

MADJAX

Part # 24-139

Will fit Yamaha® Drive 2® AC ONLY



INSTALLATION INSTRUCTIONS

TOOLS NEEDED

Mechanics Tool Set
Cordless Drill
Rivet Gun
Sawzall
Speed Square
Tape Measure
Floor Jacks
Jack Stands
Marking Pen
Drill Set
8-10" Sawzall Blades

ITEMS INCLUDED

Front Threshold
Rear Threshold
Rear Trim Cover
Frame Extensions
Side Floor Supports
Center Floor Support
Brake Cables
Battery Meter Harness
F-N-R Extension harness
Key Switch Extension harness
Reverse Buzzer extension harness
Pedal Safety extension harness
Throttle Sensor extension harness

Tail Light extension harnesses
Light Kit Power extension harness
USB extension harness
Cup Holder
Seat Frame Closeouts
Rear Grab Bar
Seat Frame
Seat Frame Supports
Floor Cover Plate
Floor Mat Retainers
Horn Harness
Hardware Packs



Floor Mat



Cup holder

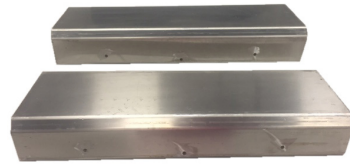

Side Floor Supports

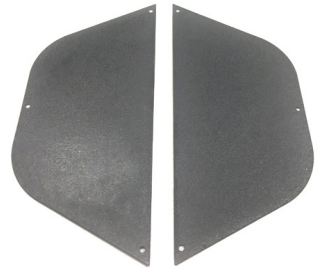

Seat Frame Closeouts



Rear Grab Bar



Seat Frame Supports



Rear Threshold



Front threshold



Rear Trim Cover

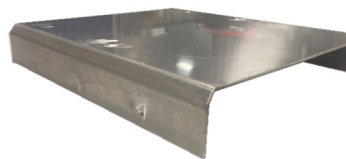

Center Floor Support



Floor mat retainers

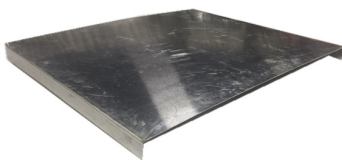

Floor cover plate



Frame extensions



Light kit power wire extensions

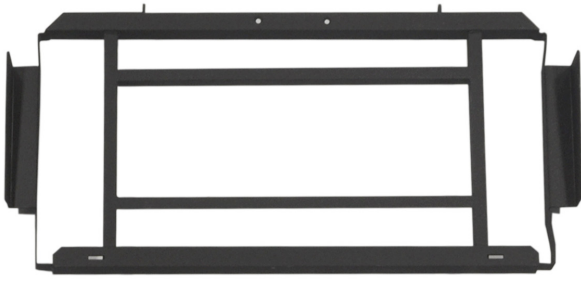

Seat Frame



Extended Brake Cables
x2



FNR Harness



Keyswitch Harness



Battery Meter Harness



Pedal Safety
Harness



To USB Harness



Reverse Buzzer Harness

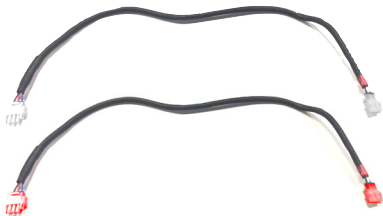

Tail light Extension
Harnesses



Horn Harness



Throttle Sensor

We recommend professional installation. If you choose to not have this product installed by a professional, we highly recommend that you exercise caution, care, and patience when installing this product.

STEP 1

Switch key into the OFF position, chock front and rear wheels, and flip cart into TOW mode.

*Remove factory Canopy, Rear Struts, Sweater Basket, Front Seat Cushions, and Rear Seat Kit if applicable. Retain Front Seat Cushions and hardware.

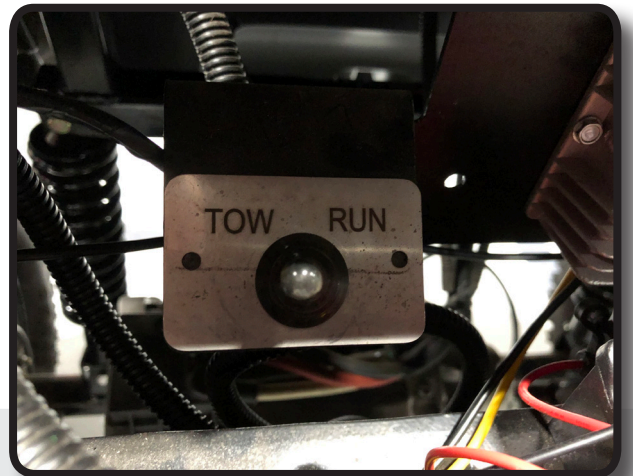

STEP 2

Remove Floormat and retain push rivets only. A new Floormat is provided with your kit.

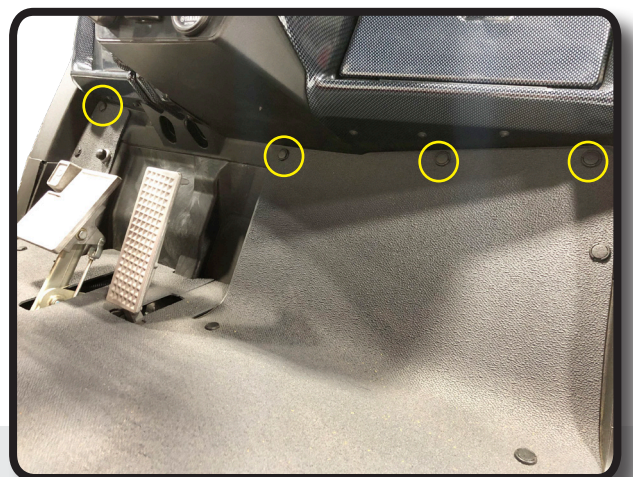
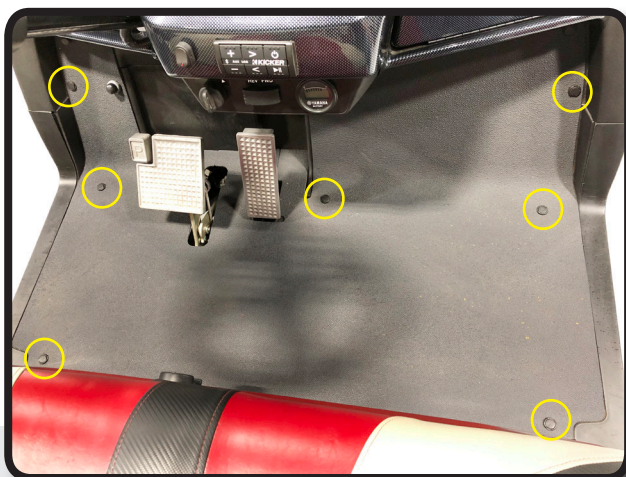

STEP 3

Using a small flat head screwdriver, remove the Yamaha emblem from the cup holder and retain. Then remove the set screw with a 3mm Allen wrench and retain. You can now remove the cup holder from the dash by lifting up and away from the front cowl. Retain cup holder.

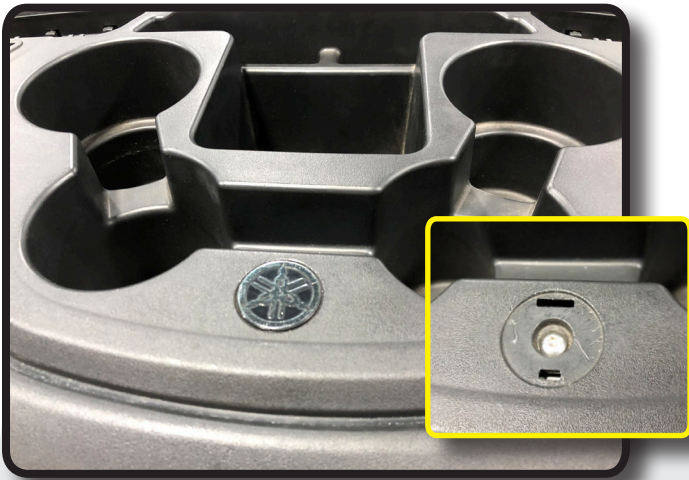

STEP 4

Remove and retain the 3 push rivets shown.



STEP 5

Disconnect Key Switch, F-N-R, Battery Meter, USB charge ports, and any other accessories attached to front dash. Take pictures of wire connections for easier reattachment later.

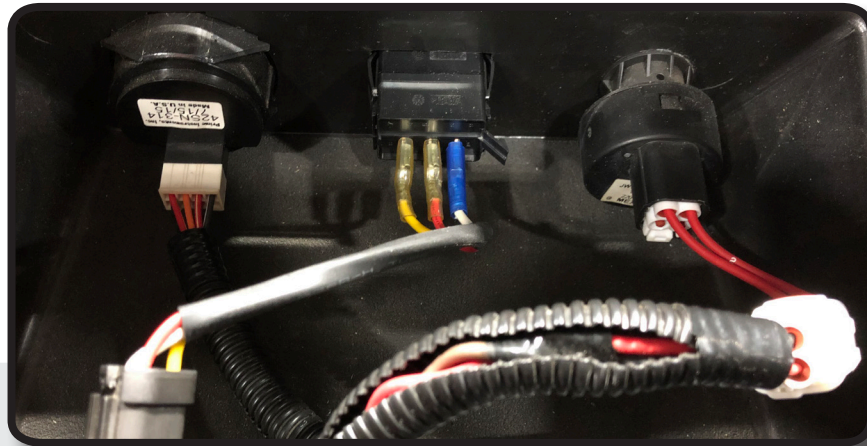

STEP 6

Remove and retain the rivet located under the dash and behind the Brake pedal shown. You will also need to remove the steering wheel to completely free dash panel.

Use a 17mm Socket to free steering wheel. Once steering wheel is removed, slide off and retain the column cover. You can now remove front dash and retain.



STEP 7

To remove front cowl, first disconnect front headlights if applicable. Then push in the 4 **Cowl Clips** shown to free from front underbody. Now remove and retain Push Rivets from front tire wells.

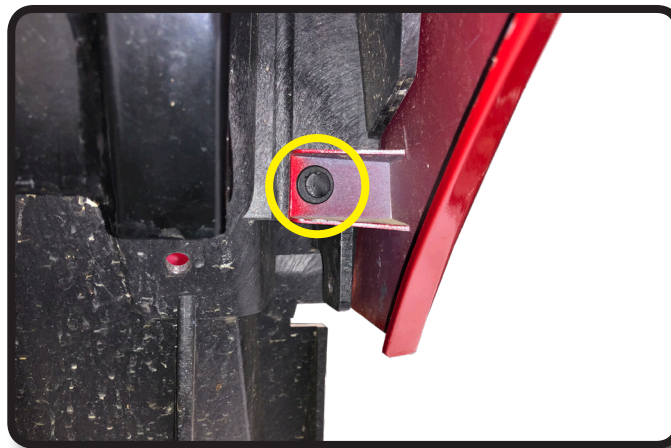
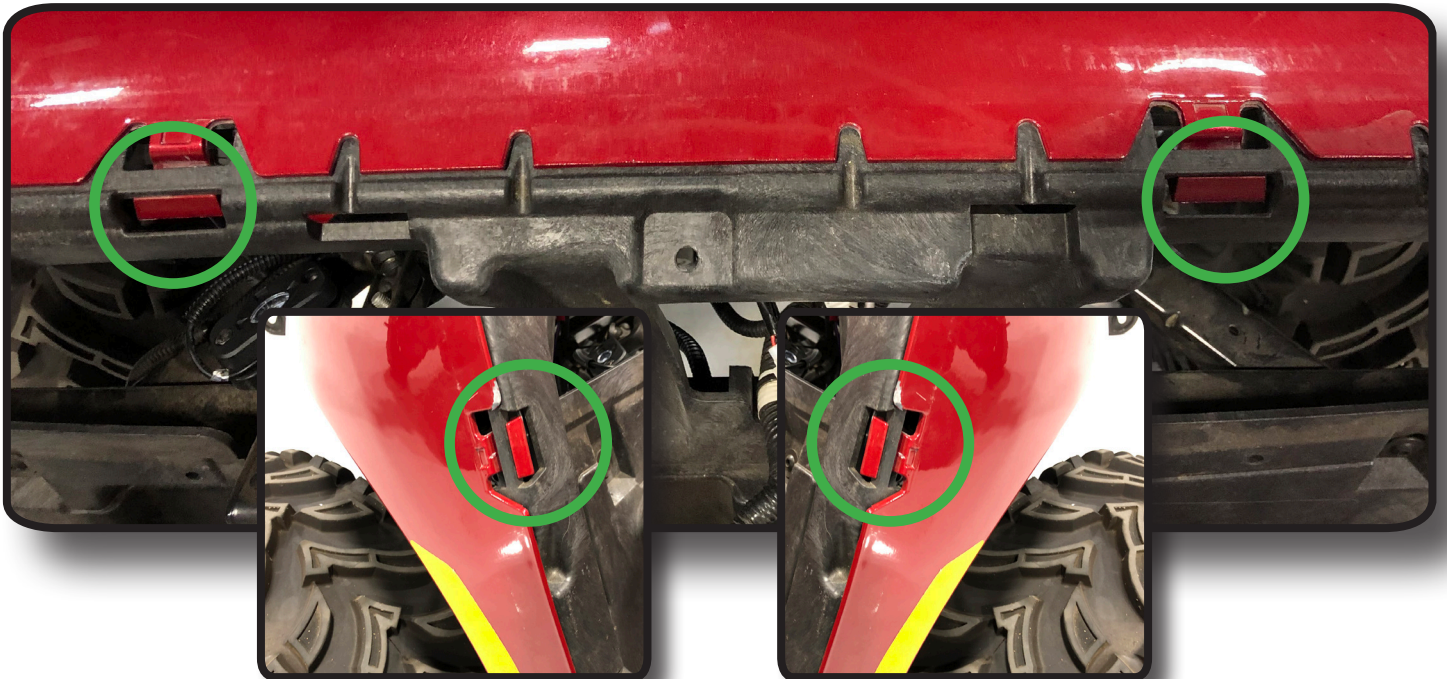

Finally, using a 10mm socket remove and retain the set screw holding the front of the cowl to the front frame.

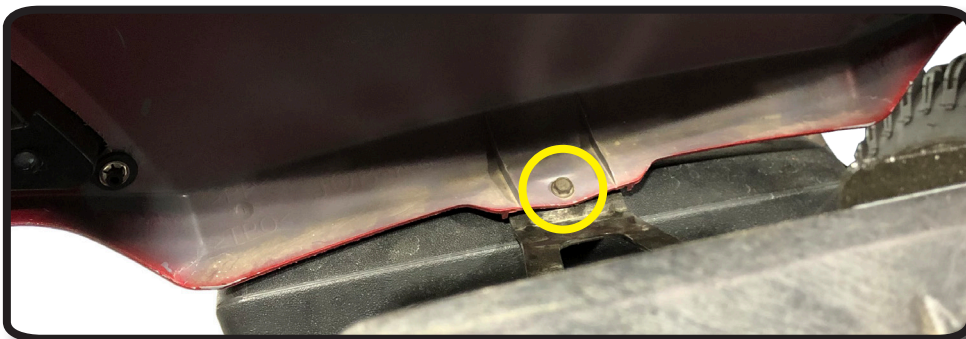

STEP 8

Remove and retain side skirts by removing the 6 rivets per side.

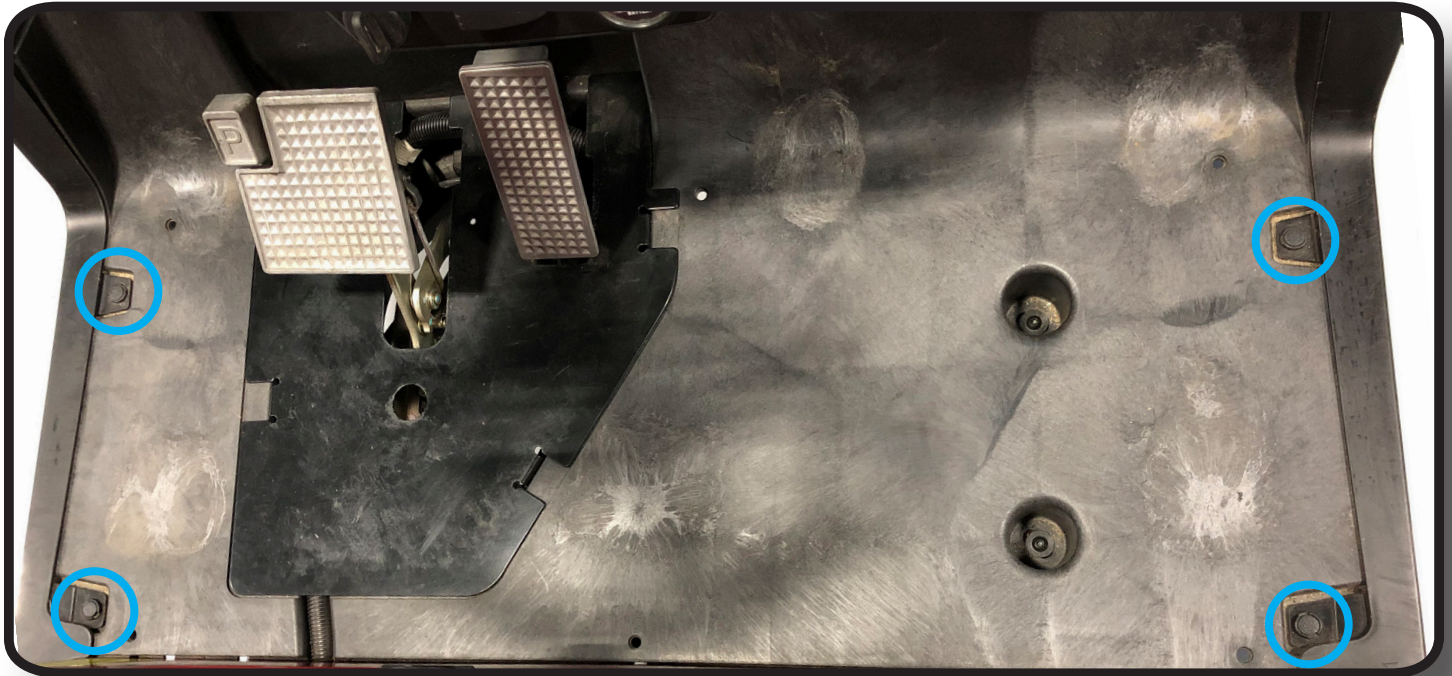

- 2 in floor
- 1 in front underbody
- 1 at rear corners of battery box
- 2 in rear tire well

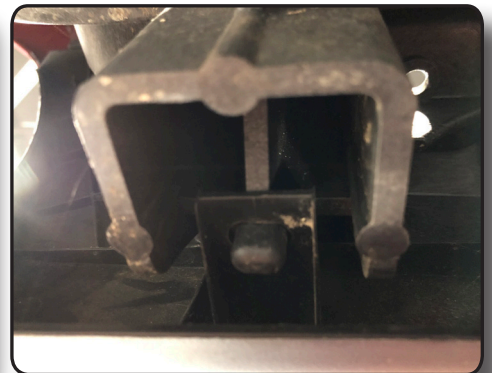
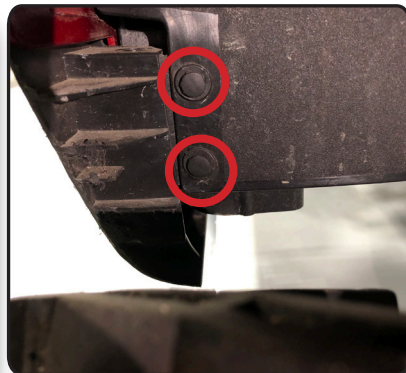

There are 3 tabs located under cart that secure each side skirt, once the rivets are all removed pull the side skirt free from tabs.

STEP 9

Remove and retain Pedal Assembly access cover from floorboard.



Remove and retain **pin & clips** from front of brake cables as shown. Remove and retain **cable clips** from brake cable housing. Pull back cable sleeve to expose cable, push brake cable towards rear of cart to free from pedal bracket as shown.

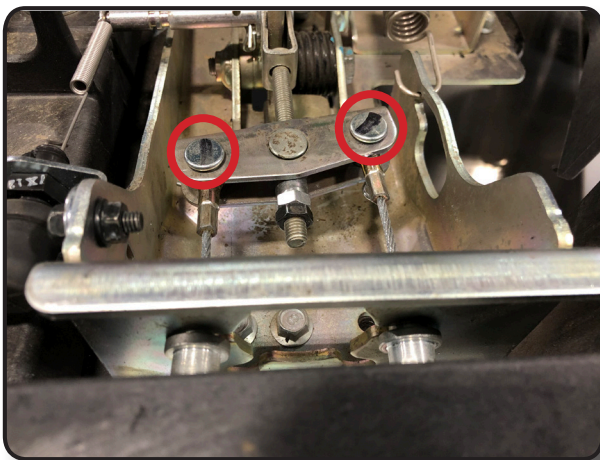

STEP 10

To release brake cable from rear wheel hubs, first remove and retain the pin & cotter pins holding cable as shown.

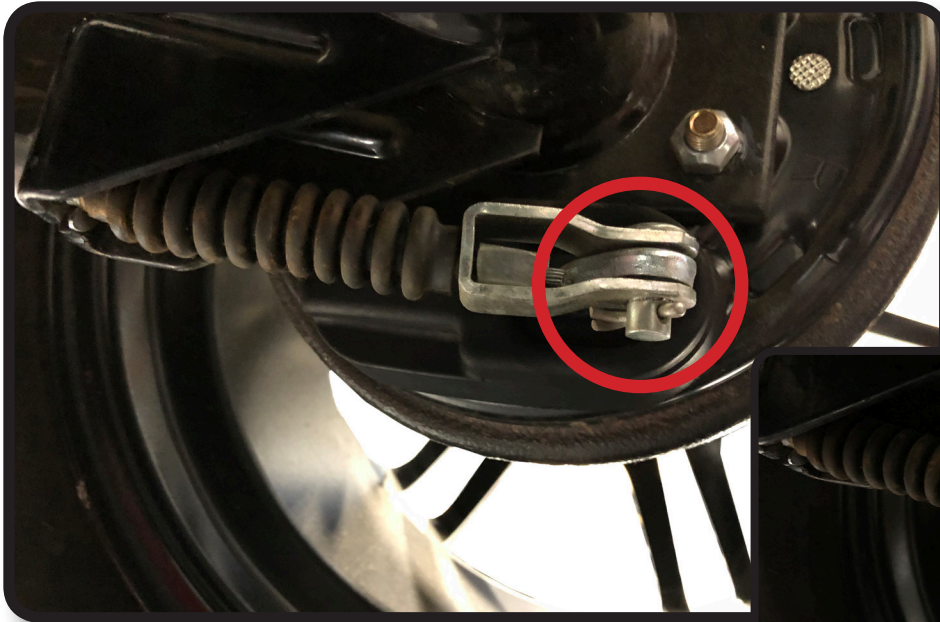

Remove and retain factory E-clips from brake cable. Pull back cable sleeve to expose raw cable, then push brake cable towards the front of cart to free from mount as shown.



- STEP 11** **A)** Disconnect Pedal Switch (gray wire) and Throttle Sensor from Accelerator as shown.
- B)** Now pull factory harness down from front dash area, through pedal access, and up along the front of rear body as shown. Secure in place.

***You will need to disconnect the factory horn, reverse buzzer, and brake switch if applicable.**

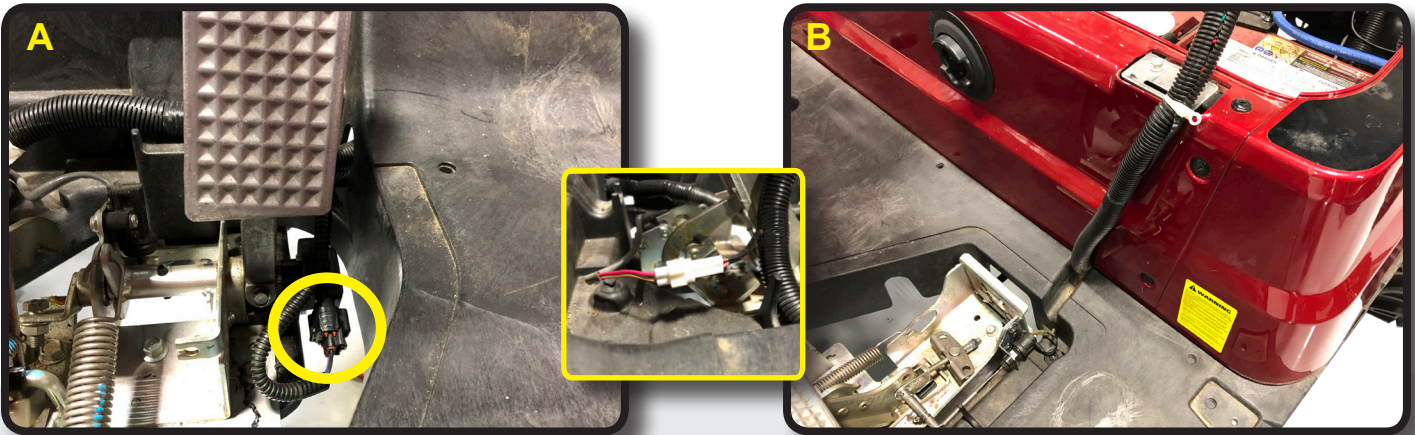

- STEP 12** Make a cut line that is approximately 2 1/8" off rear body. Use a chalk line or straight 6' level to ensure line is true. Notice the line is even with the rear indentation for the brake access cover. **Be sure cut line is exactly as shown.** Side skirts will be cut later.

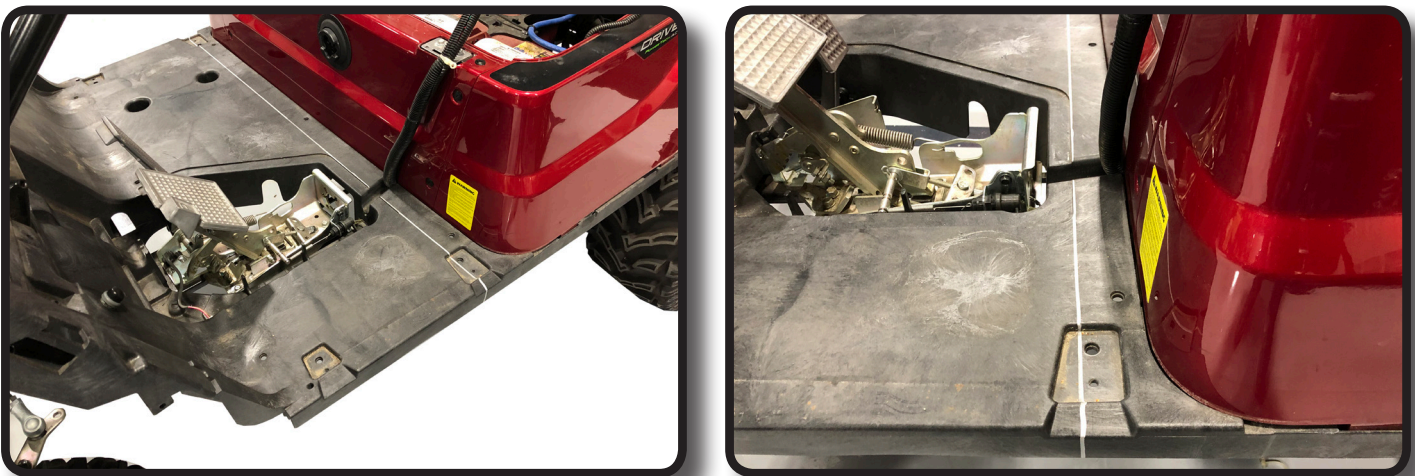

Before cutting car check again for any hidden harnesses, LED light strips, speaker wire, etc that can be damaged if cut.

STEP 13 Using a sawzall or skil saw cut plastic underbody only. Do **NOT** cut into frame until after STEP 22.



STEP 14 Detach front underbody by removing the 7 bolts as shown with a 5mm Allen head socket. Only (3) of the bolts will be retained, the others will be replaced with new supplied hardware.

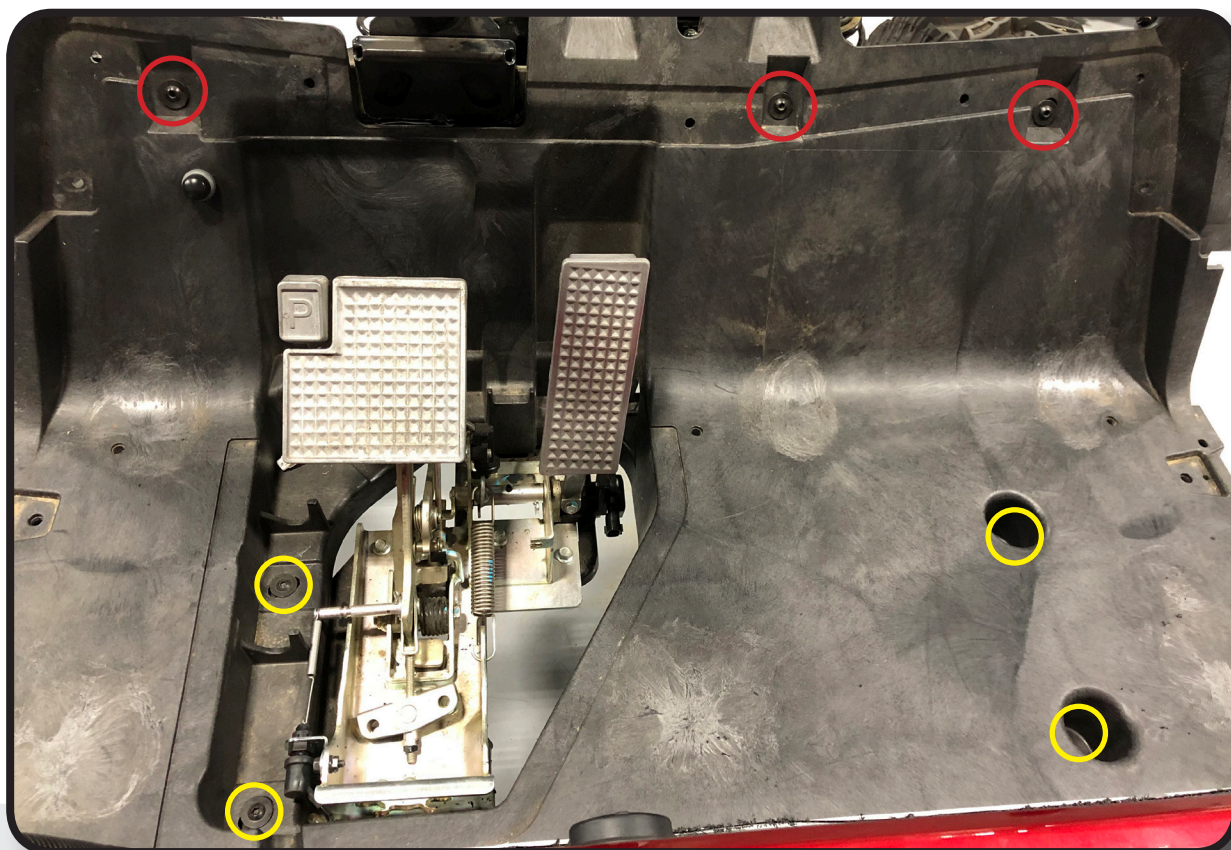

STEP 15

To easily remove the front underbody you will need to temporarily remove the steering column from the mount as shown using a 12mm Socket.

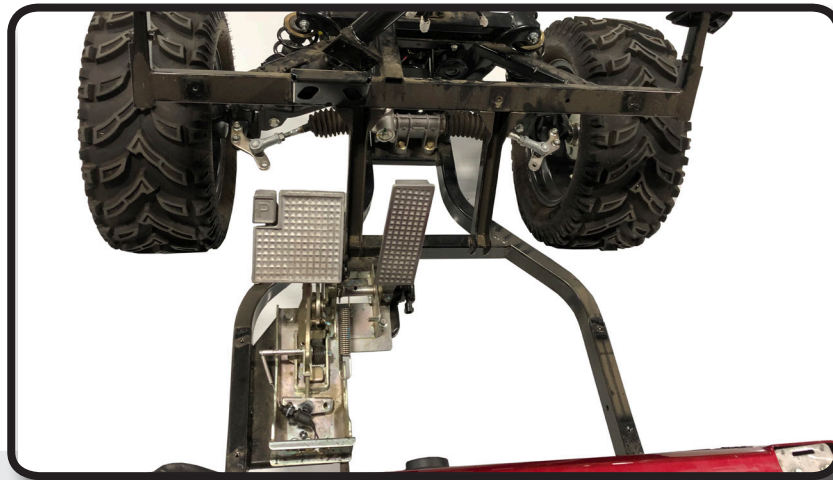
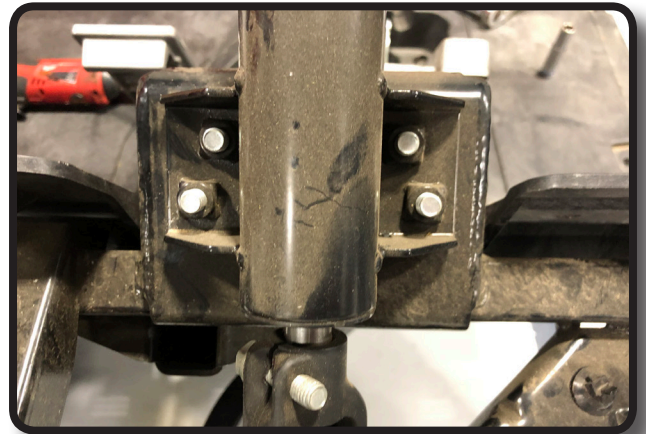
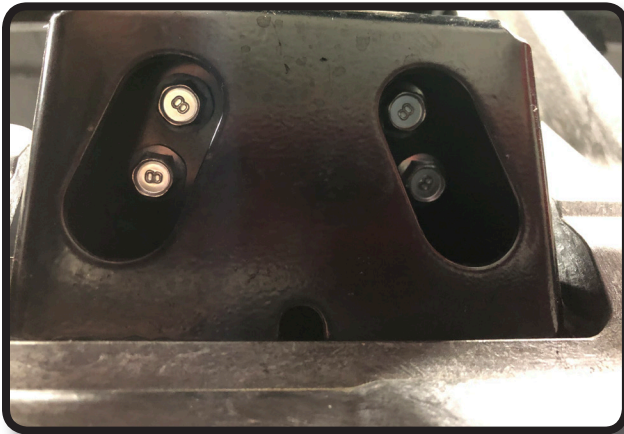

STEP 16

Before cutting frame make sure to support frame on both sides of the cut line and recheck to make sure your front and rear tires are chocked. After the next step the cart will try to roll if not properly secured.



STEP 17

Using a square mark the frame using the plastic underbody cut as a guide. You will need to mark the pedal bar as well. Cut all 3 pieces as shown.

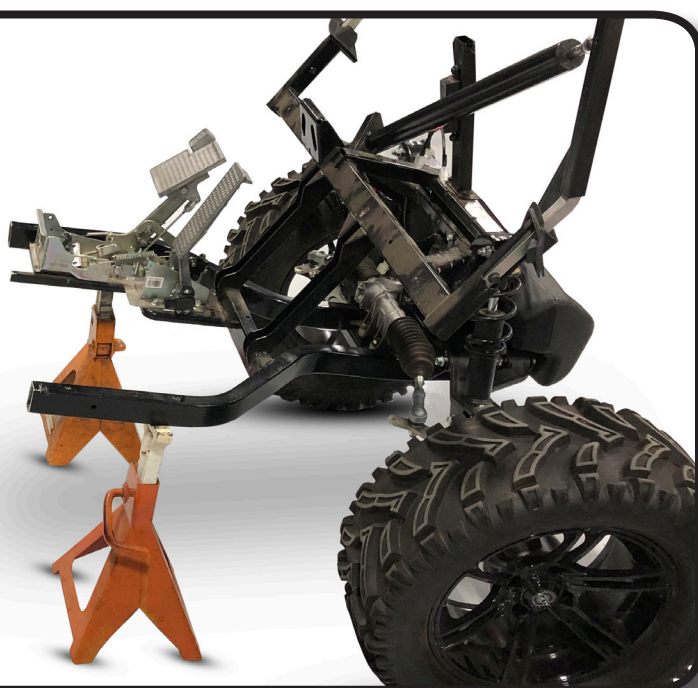
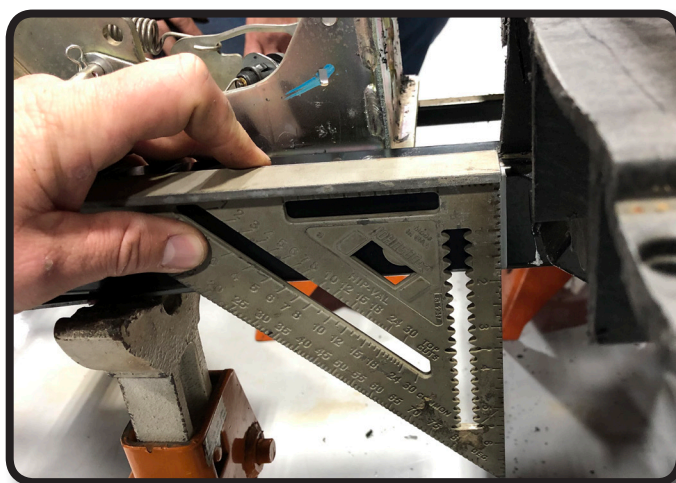
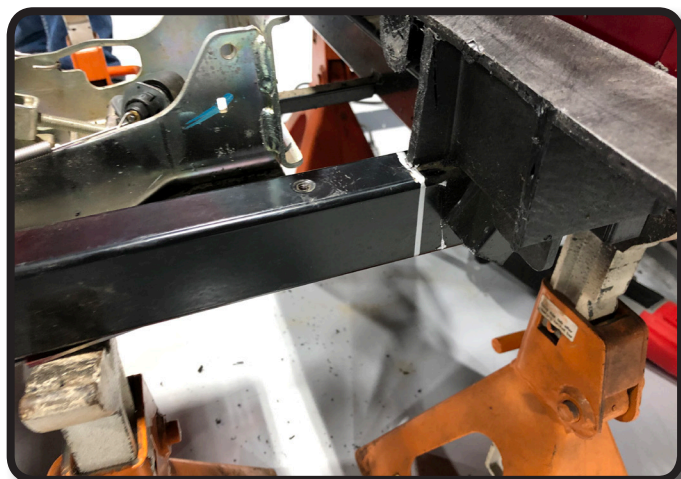

STEP 18

The Frame Extensions are identical but they are also directional. Insert the end of the extensions with **NO** pre-drilled vertical holes into the rear frame as shown.

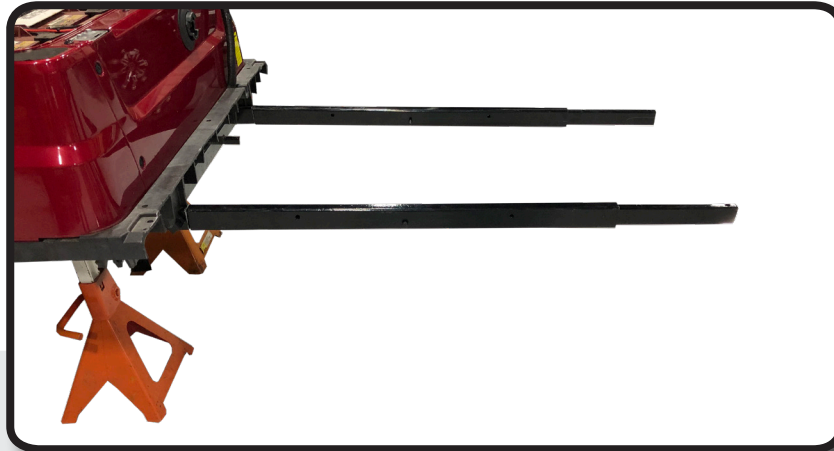

STEP 19

Using a 11/32" bit, drill out tapped holes in front frames to remove debris and allow extensions to fully insert into frame. Once holes are clear roll car front on to extensions.

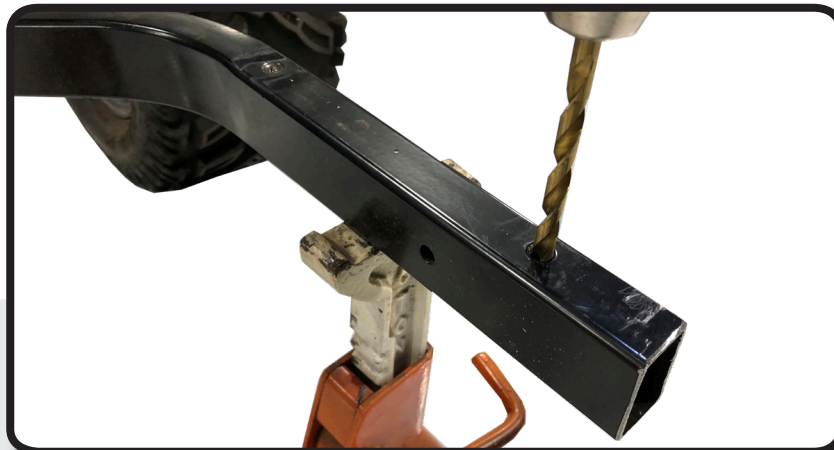

STEP 20

Ensure frames are tight up against the extension covers and the holes on the side of extensions are properly aligned. Then chock all four wheels again to keep both ends in place. Using front frame holes as a guide, drill through extensions and lower part of frame with a 11/32" bit as shown.

NOTE: Drill a 1/8" pilot hole to make drilling through extensions easier.

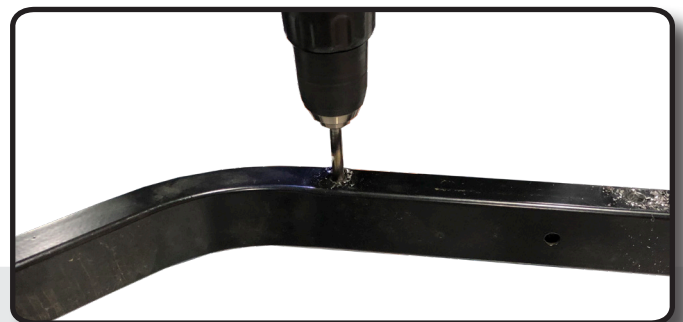
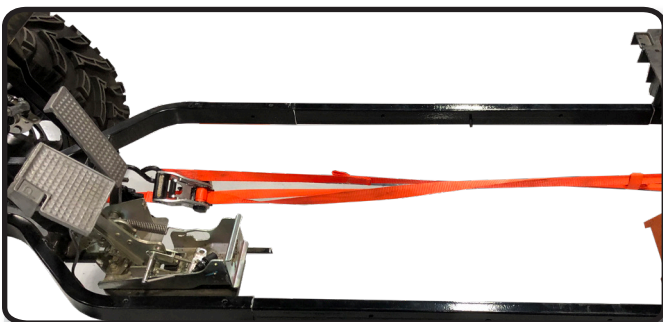

STEP 21

- A) Reattach floor board to frame using the 3 retained bolts from STEP 14.
B) Using the four 8mm x 75mm bolts, fender washers, and hardware from Pack 1 attach to frame at the marked locations.

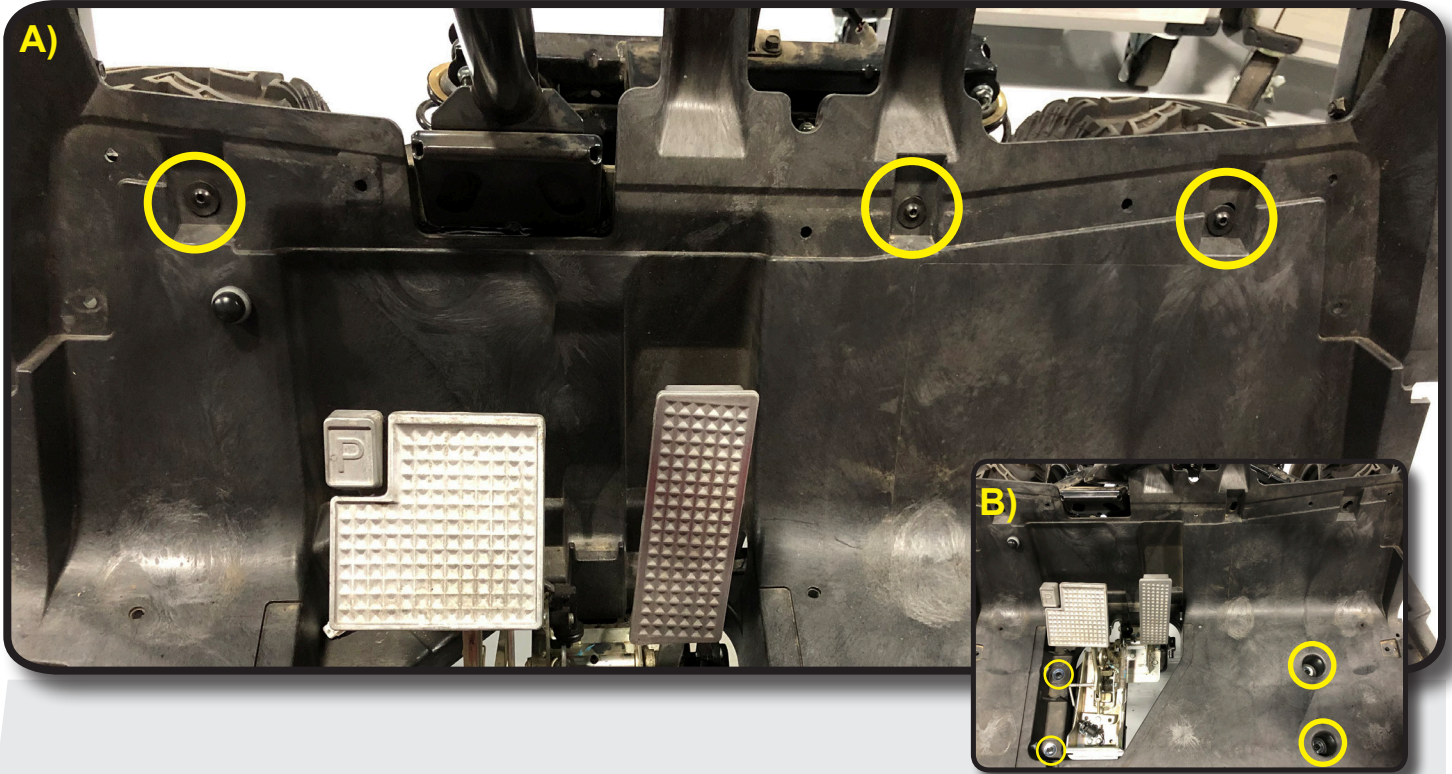

STEP 22

You can now reattach the steering column using the retained hardware from STEP 15.



STEP 23 To attach the rear end of the extensions you will need to drill two holes in each side of the rear frame. Locate the angled tube shown under the battery compartment and just behind where the frame was cut. **A)** Mark a drill hole on the angled tube that lines up with the center of the carts frame. **B)** Using a metal step up drill bit, drill a 11/16" hole in the angled tube as shown.

*This will allow bolt head to easily fit through tubing to secure rear of frame extensions

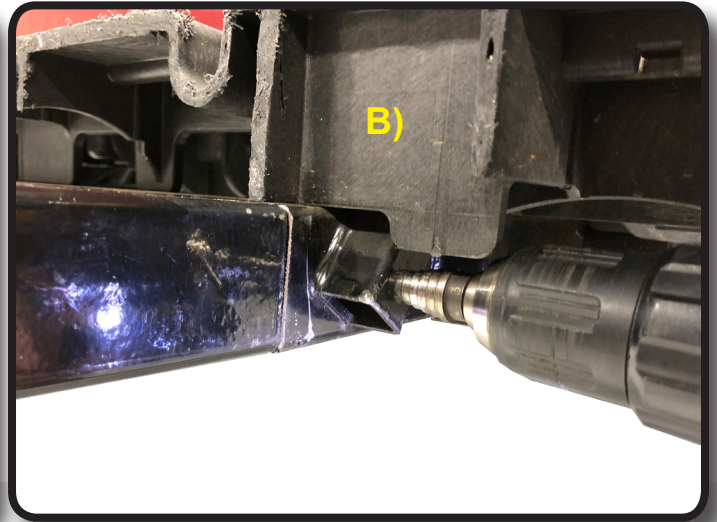
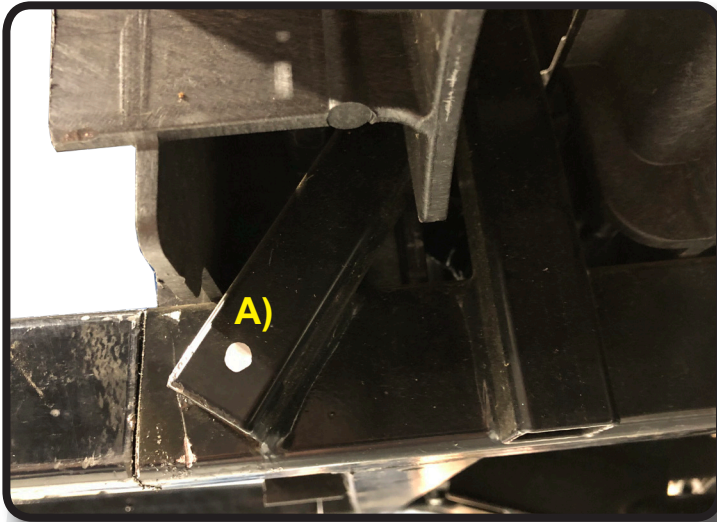

STEP 24 Using a 5/16" bit, drill all the way through the frame and frame extensions. Use a 1/8" bit to drill a pilot hole. Once hole is drilled through frame, use a 8mm x 45mm bolt and hardware from Pack 1 to secure extension in frame. Do not tighten until all 4 holes are drilled and bolts are in place. Repeat steps 23 and 24 on opposite side of frame.

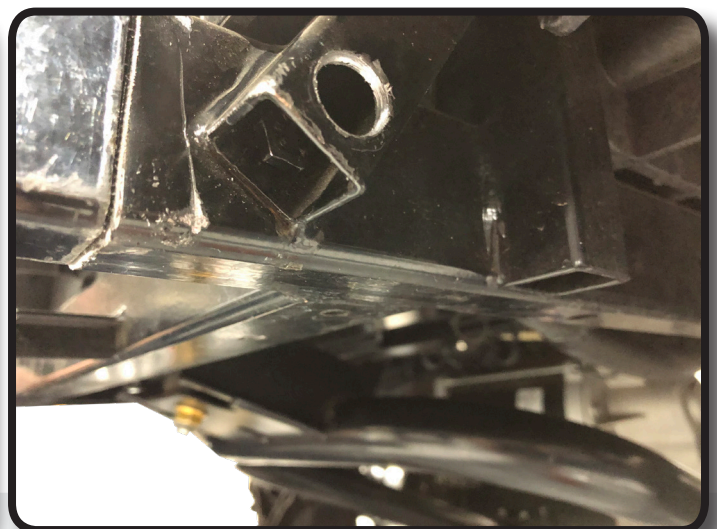
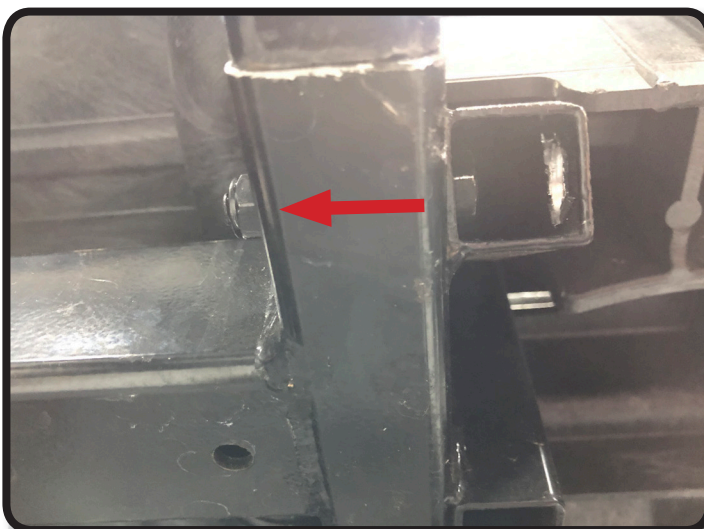

STEP 25 Using a 1/8" bit, drill a pilot hole through the frame 2" from rear cross member as shown. Once pilot hole is drilled, use a 5/16" bit and drill out hole. Secure rear of frame extensions with the 8mm x 45mm bolts and hardware from Pack 1.

Note: You may need to release the main harness from the frame clip to avoid damaging the harness while drilling. Repeat on opposite side and tighten all hardware.

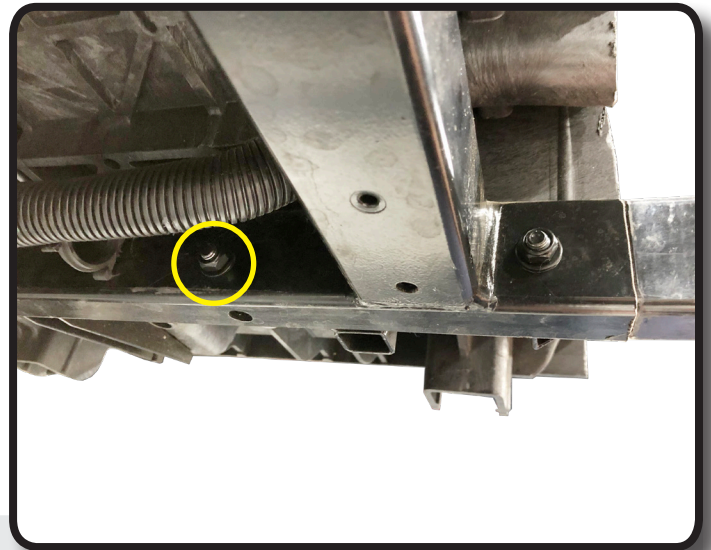
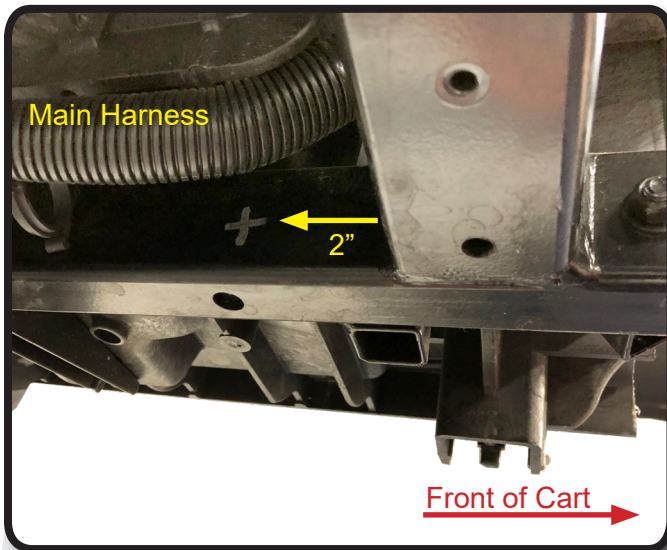

STEP 26 You can now attach the new Brake Cables to the rear hubs. Slide the cable sleeve back to expose the raw cable and insert into cable mount. Push cable housing into mount and secure with retained E-clip from STEP 10. There is no passenger or driver side, cables are identical.



STEP 27

Secure end of brake cables using the retained pin & cotter pins from STEP 10.

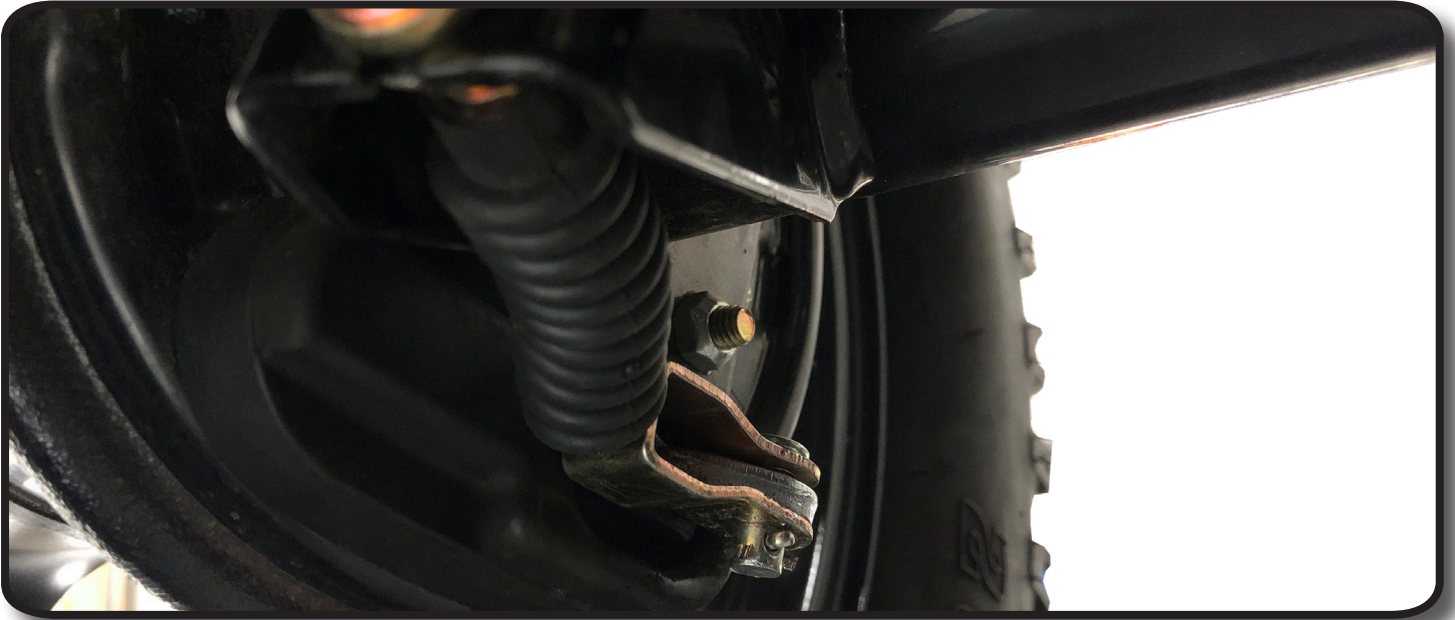

STEP 28

Route front of brake cables through frame clamps and over cross member on driver's side of frame as shown.

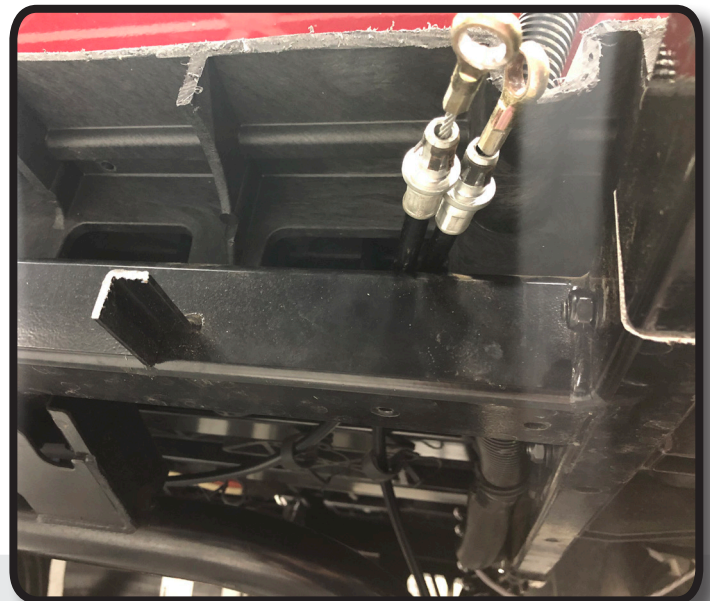

STEP 29

A) Push cables into pedal assembly mount so cable clips hold cable into pedal mount as shown. **B)** Then attach front of brake cables to brake mount using retained hardware from STEP 9.

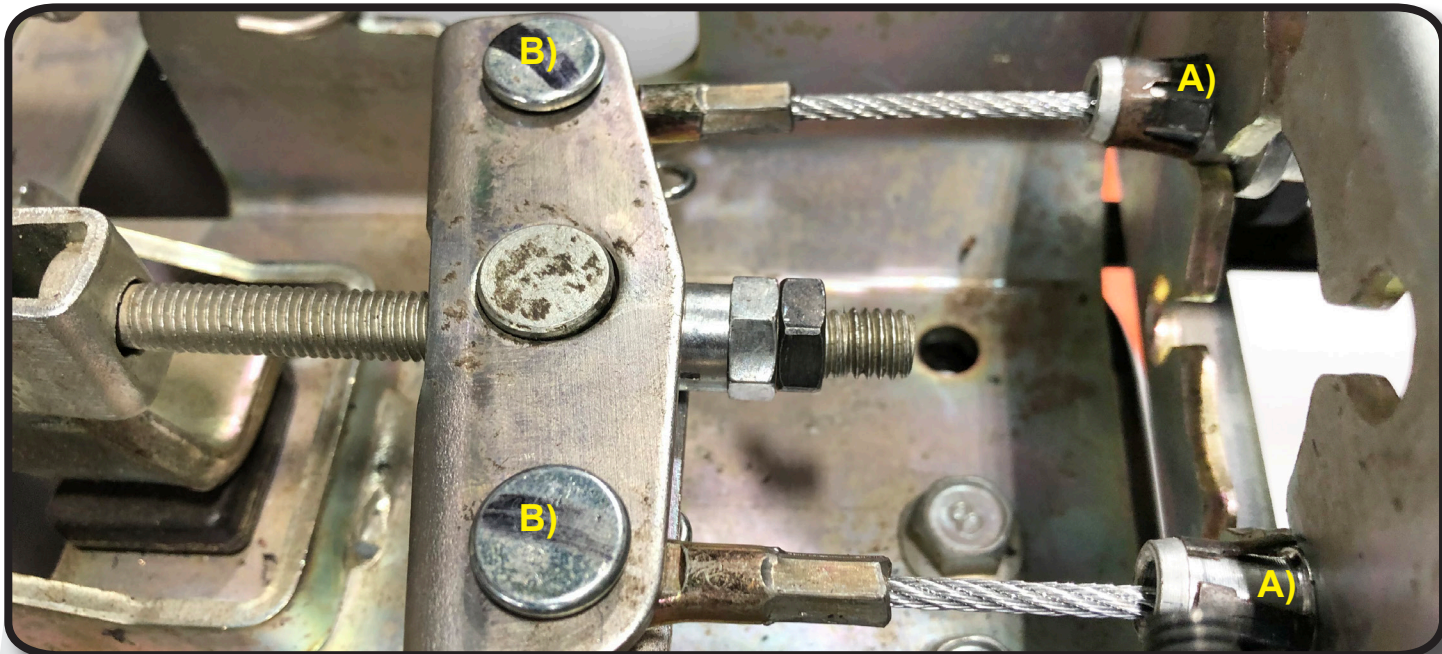

STEP 30

Once cables are secure now is a good time to check the brake sensitivity. Remove wheel chocks and roll cart forward to check brakes. To adjust brakes use a 12mm wrench to loosen jam nut. Adjust brake sensitivity by turning adjustment nut as needed.

Note: You should get two clicks from the brake pedal when fully engaged. With brake set after two clicks the cart should not be able to roll forward. Once brakes are properly set secure by re-tightening jam nut to adjustment nut.

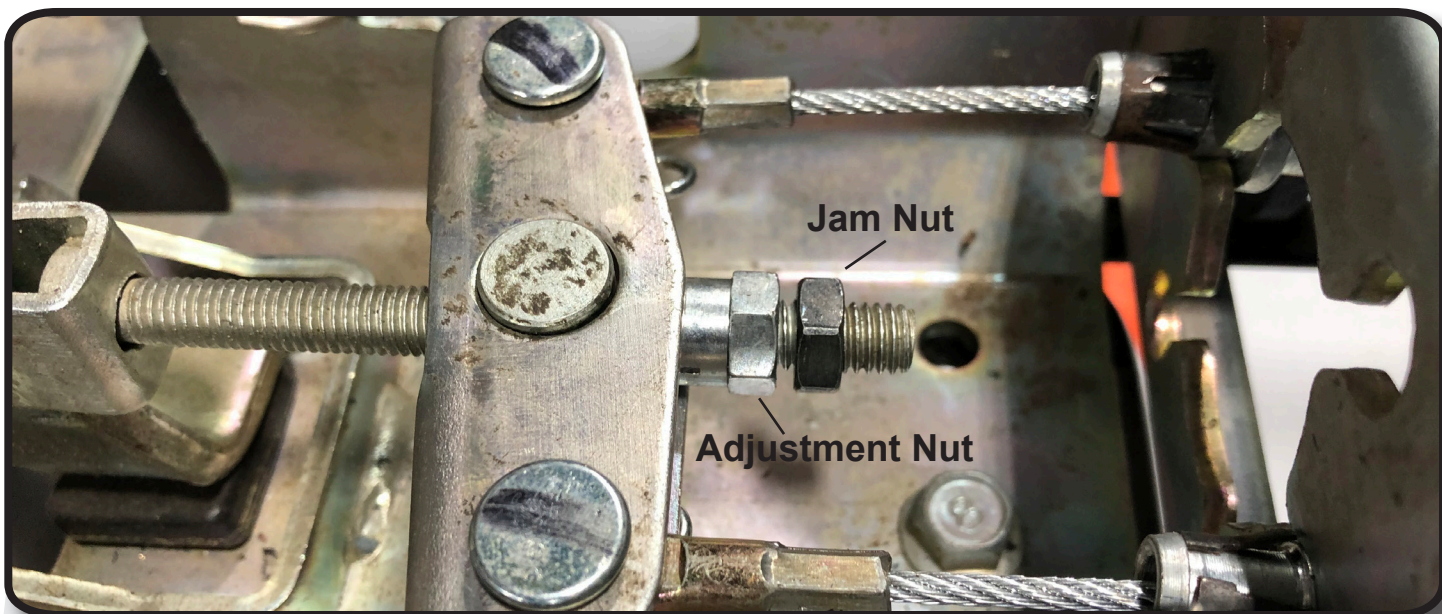

STEP 31

A) Using the six 8mm x 55mm bolts from Pack 2, attach the Side Supports to the frame extensions. Do NOT push bolt all the way through the frame until after Center Floor Pan is installed. **B)** Insert center floor pan between frames as shown, make sure the 4 holes in the center pan are offset to the front of the cart and push 6 bolts through extensions and into center pan. Once all 6 bolts are in place, then tighten hardware.

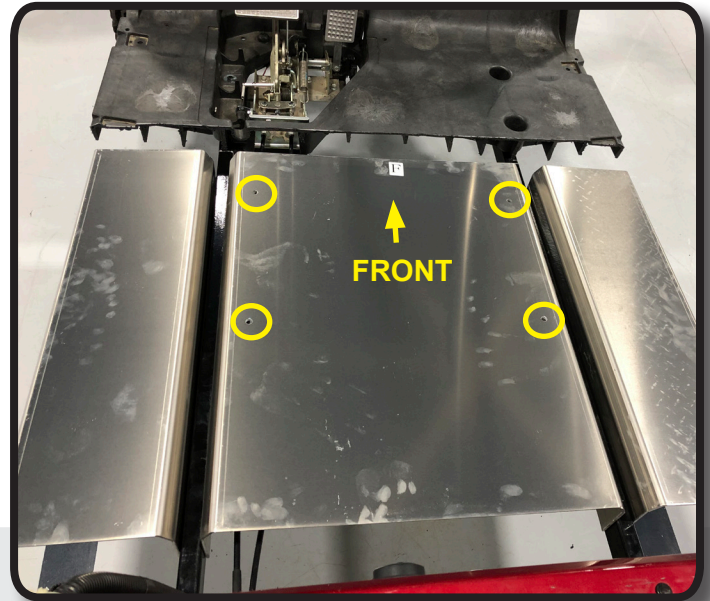
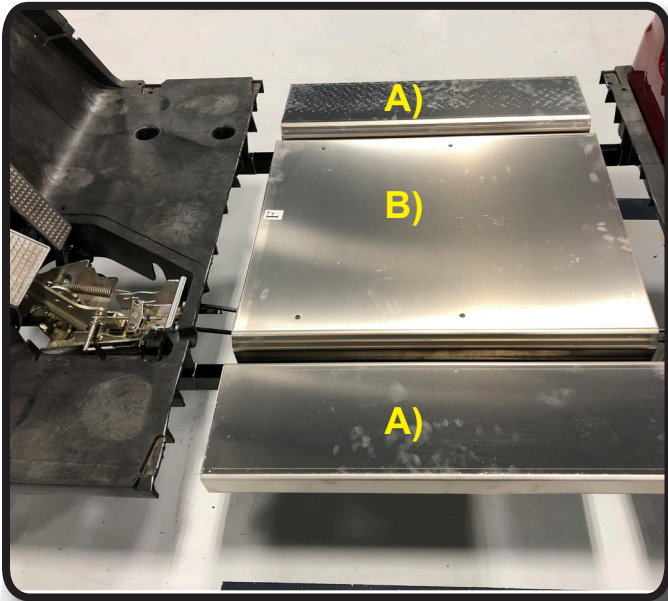

STEP 32

You can now run the main cart harness down the driver side channel as shown and into the pedal access. Connect the Pedal Safety Extension harness to the main harness as shown and into the Pedal Switch from STEP 11.

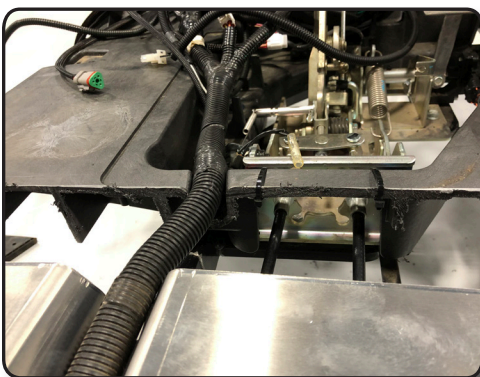

STEP 33

Connect all new extension harnesses supplied with your kit.

A) USB Port extension harness
B) Throttle Sensor extension

C) F-N-R extension
D) Key Switch

E) Battery Meter
F) Reverse Buzzer

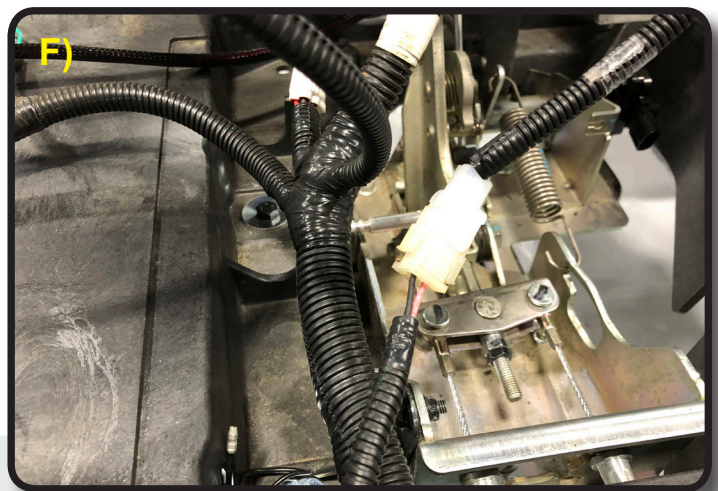
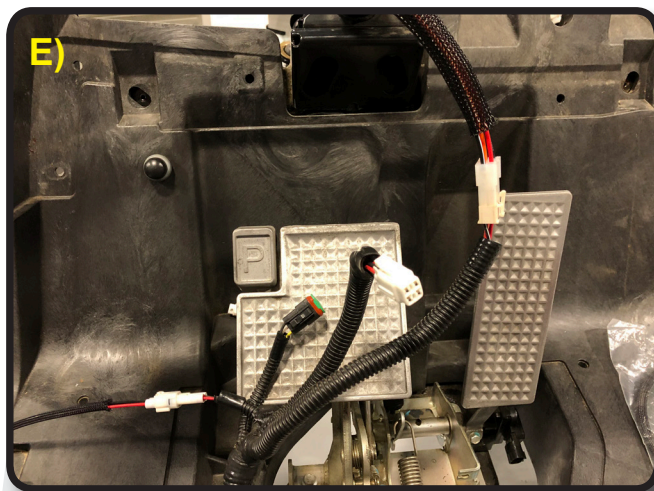
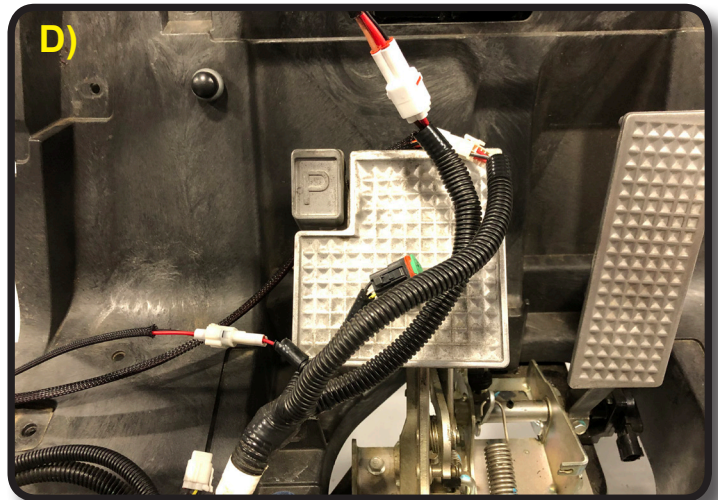
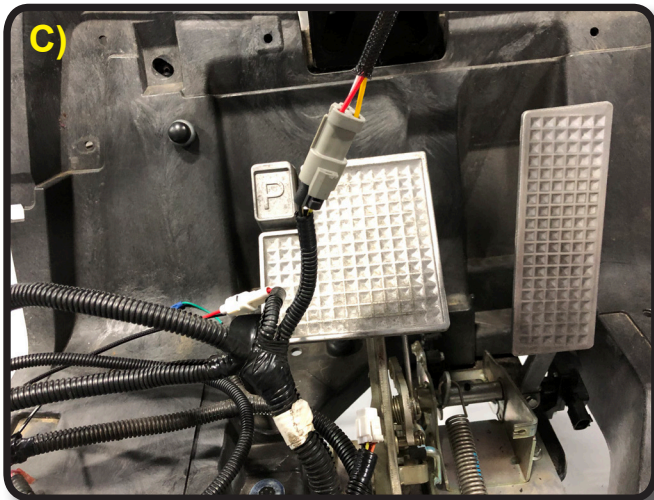
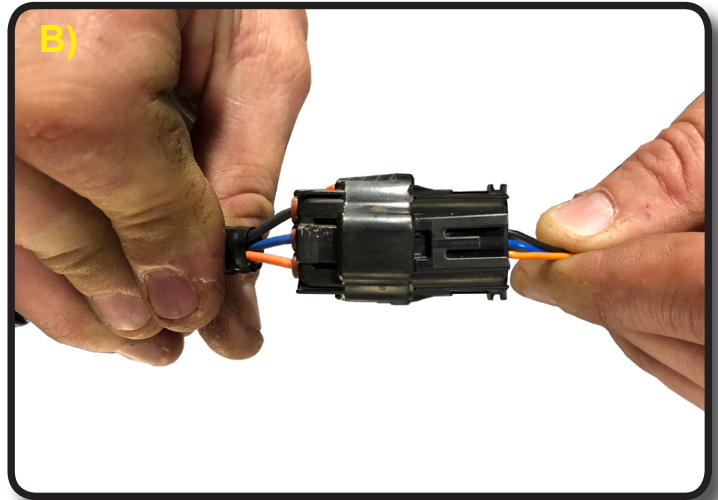
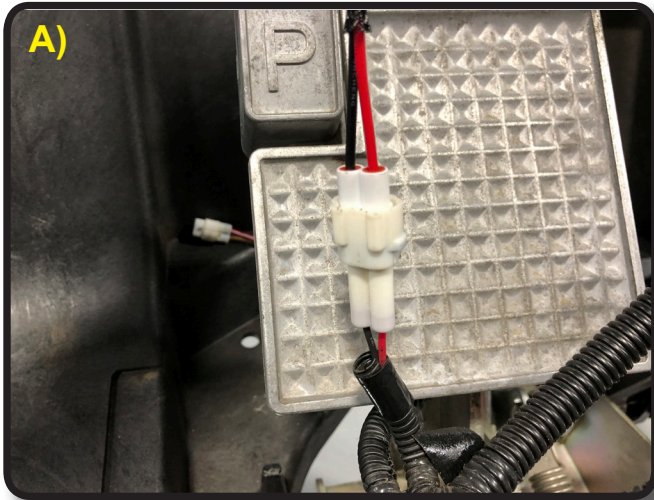

STEP 34

With extension harnesses attached, feed main harness around pedal assembly and out through access hole located behind accelerator pedal as shown. Secure with supplied zipties.

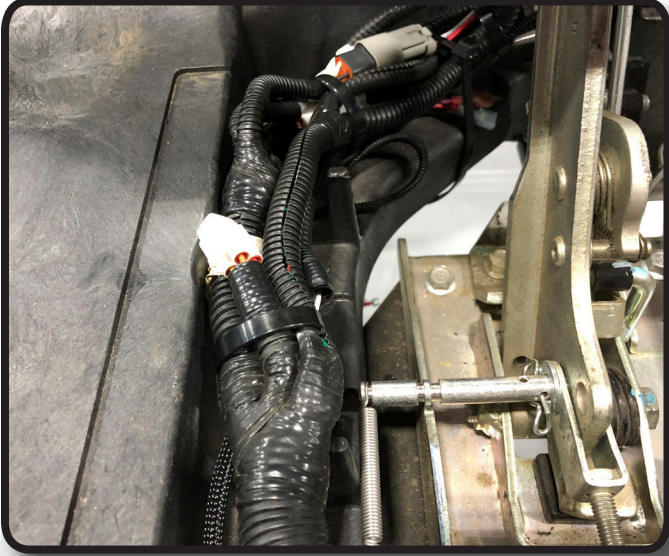

STEP 35

If you are installing or have an existing Madjax light kit, run harness from front to back. Included in your kit is a 24" red and black 16ga wire loom extension for your light kit power feed. You will need to add this loom to your light kit harness so it will reach the proper 12V battery connections.

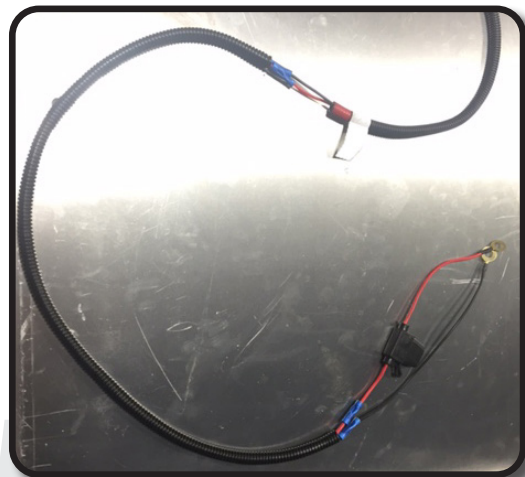
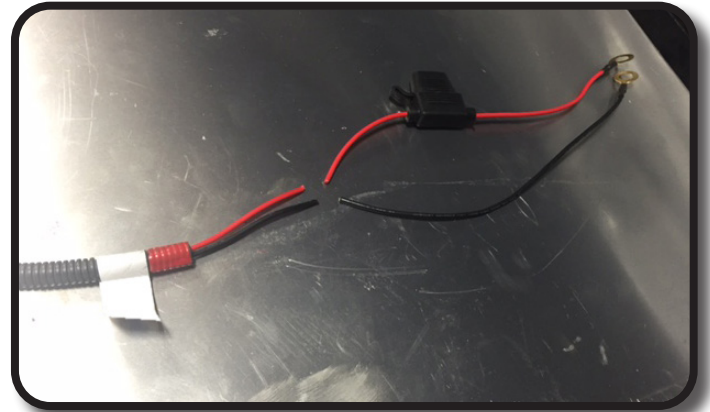
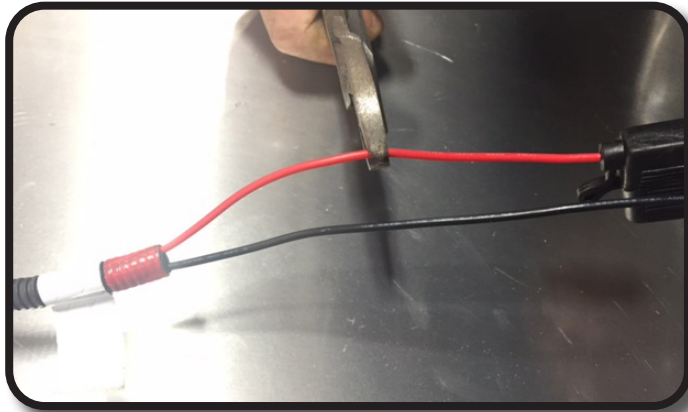

***For your tail lights we have included Tail light extension harnesses. The short red 4 pin harness is for the passenger side, white 4 pin harness is for the driver.

STEP 36 Replace Pedal assembly cover.



STEP 37 Attach side skirts to rear half of cart as shown. Secure with 3 push rivets retained from STEP 8 and be sure to hook bottom of skirt underneath cart. **NOTE:** Front half of skirt will be cut in STEP 38.



STEP 38

A) Using a speed square mark a cut line on the side skirts that lines up with the floor board cut as shown. Cut off front halves with a sawzall or hacksaw and retain. **B)** Install final retained push rivet in rear half of side skirts. Repeat on opposite side.

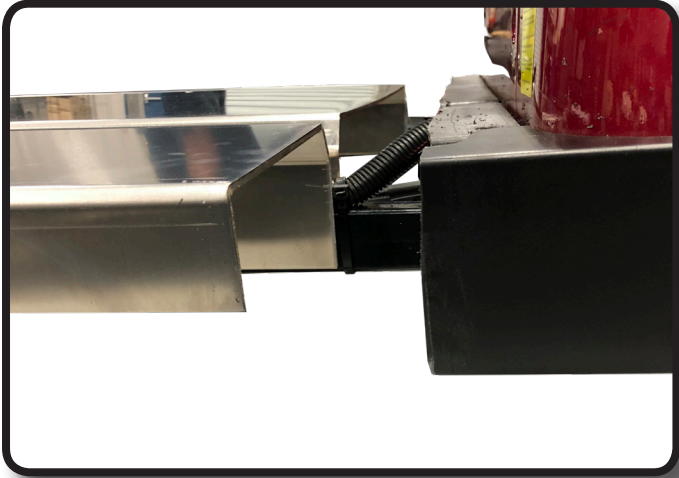
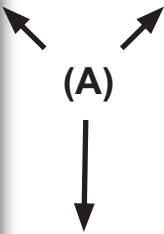
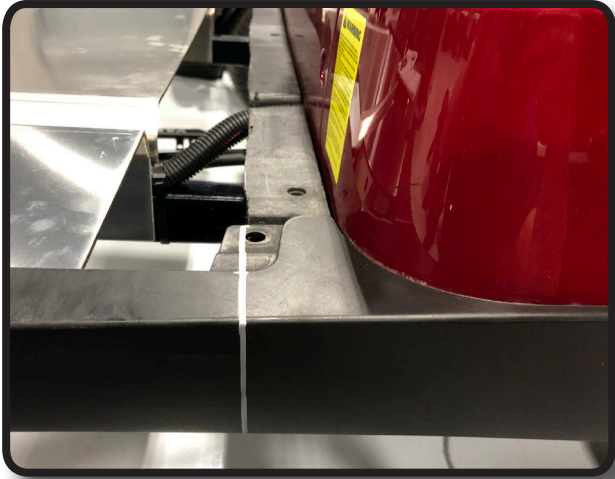

(B)

STEP 39

Attach the front side skirt halves to the cart using retained rivets from STEP 8.

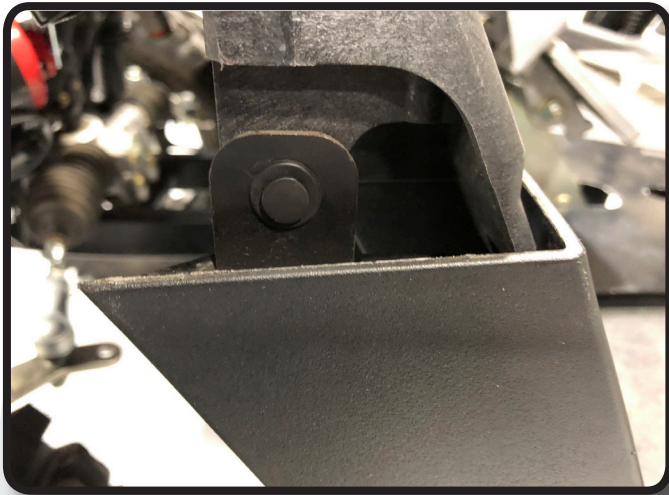

STEP 40

Reattach front cowl using retained hardware from STEP 7.
Reattach strut cover.



STEP 41 Reattach dash, column cover, and then steering wheel using retained hardware/rivets. *Make sure tires are straight before reattaching steering wheel.



STEP 42 Feed main harness with extensions behind front cowl and up to front dash area. Plug in extensions where needed. Before reinstalling cup holder be sure to check all of your carts functions. F-N-R, Keyswitch, Battery Meter, & any additional accessories. Reattach cup holder using retained hardware.

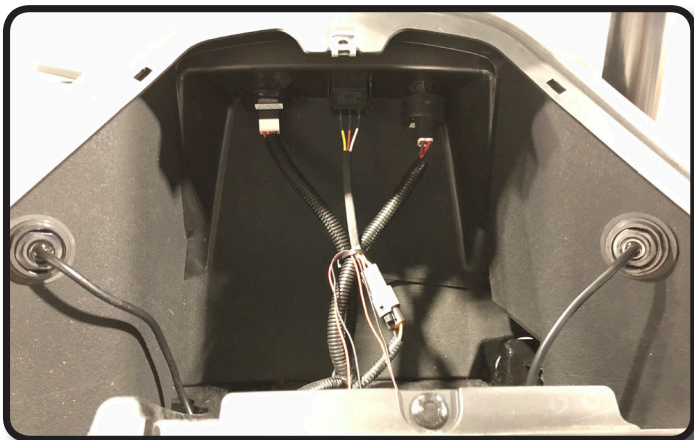

STEP 43

NOTE: In order to keep floor holes lined up for next step, temporarily place bolts from Pack 4 into holes.

A) Place Floor Cover Plate over stretch extension section with holes in cover lined up as shown. **B)** Using a 3/16" drill bit and 6 rivets from Pack 3, attach Front threshold to floor cover plate and plastic under bodies as shown. Once threshold is secured remove bolts from floor cover plate. **Note:** Rear Threshold will be secured in STEP 47.

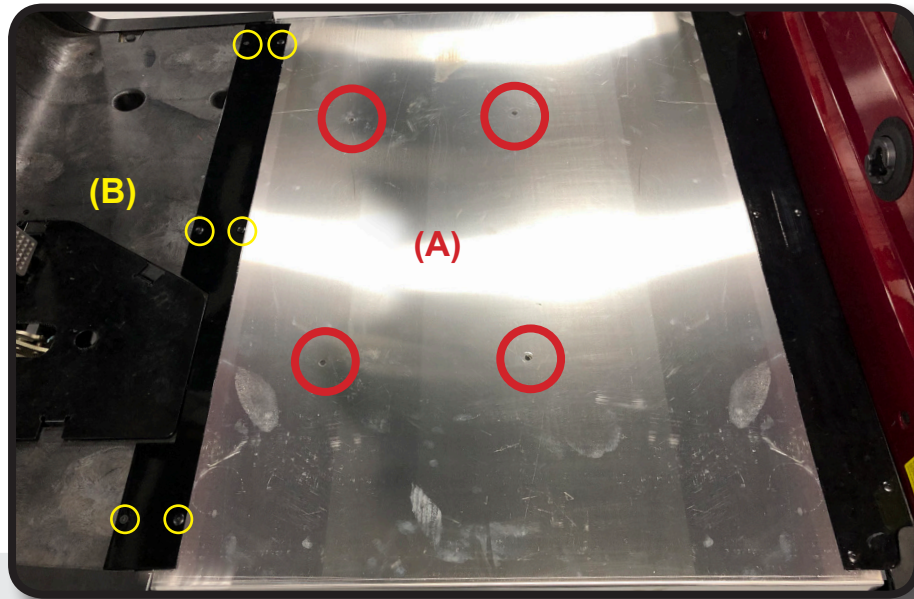

STEP 44

Lay new Floor mat across floor board and secure front with retained push rivets. Do not secure rear of mat yet.

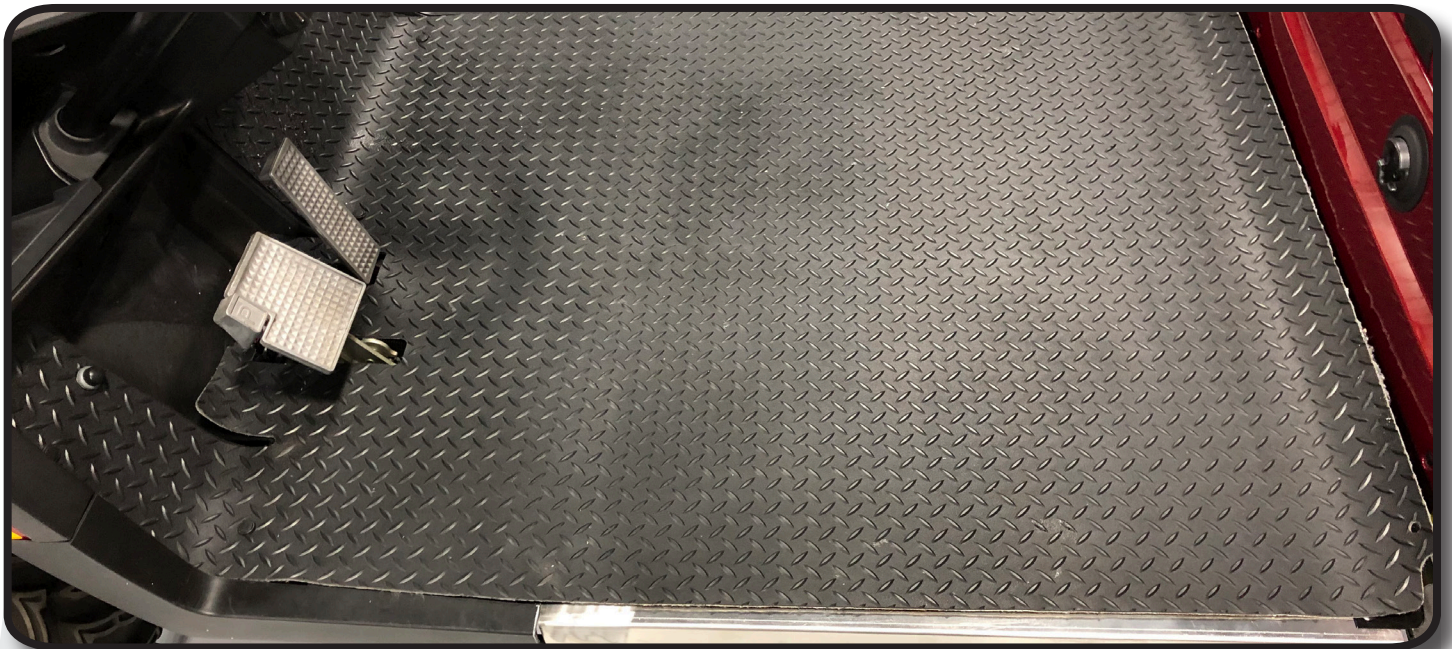

STEP 45 A) With mat in place, carefully drill 5/16" holes from underneath cart where seat frame supports will sit. Use the pre drilled holes from center floor pan as a guide.

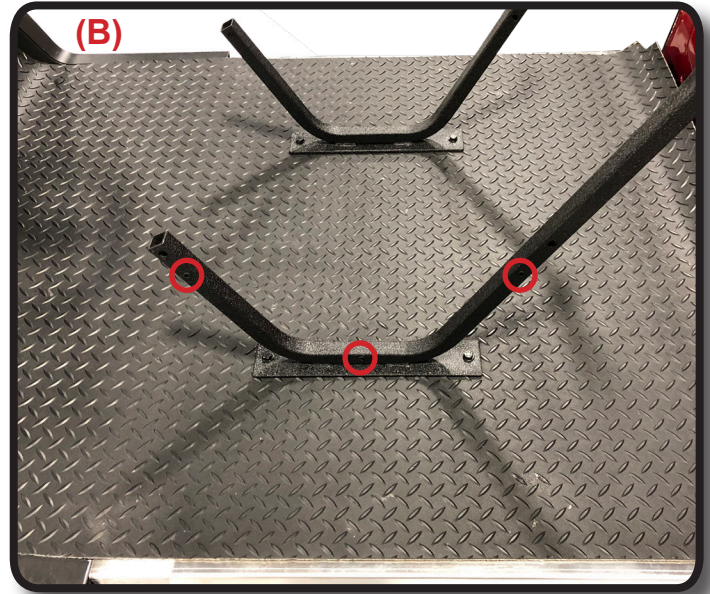
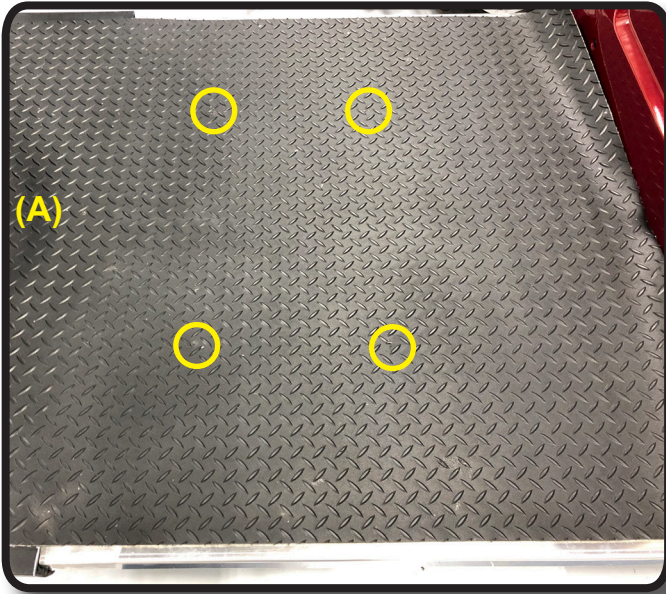

B) Secure seat frame supports to floor board using four 8x35mm bolts and hardware from Pack 4. Do NOT tighten until after STEP 50. Brass nutserts should be facing outside of car as shown.

STEP 46 Using a 3/16" drill bit and 8 rivets from Pack 3 attach Floor mat retainers as shown. Retainer should be tight up against rear body, start rivets at rear and work to front of car, 4 rivets per side.

We suggest using a C-clamp to ensure floormat retainers and floor is tightly pressed together. Use a flat metal plate or piece of wood under clamp to avoid damaging the finish

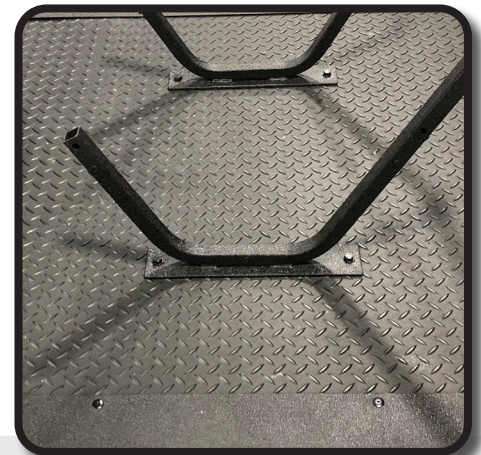

STEP 47

Install Rear trim using a 3/16" drill bit and supplied rivets. Ensure that rear threshold and Rear trim is lined up and secure each piece including the floor mat to the floor board as shown.

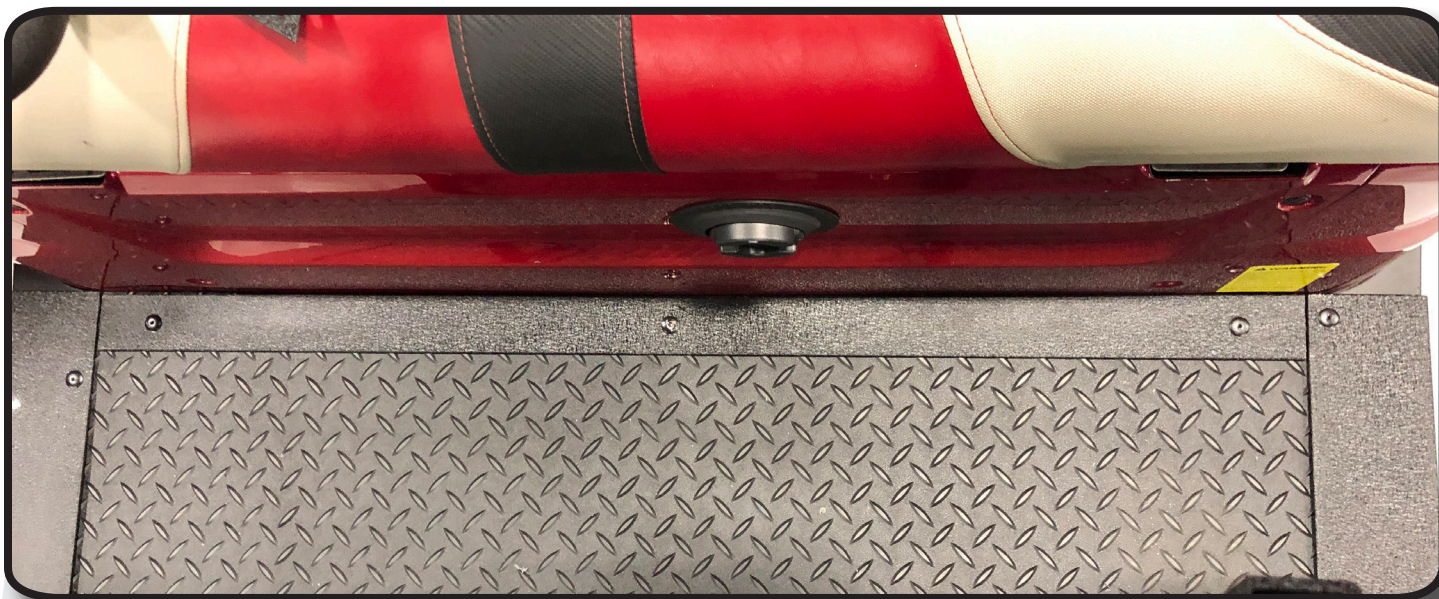

STEP 48

Attach Seat Frame to seat frame supports using four 8mm x 45mm bolts and hardware from Pack 4. Once all four bolts are in place then tighten.

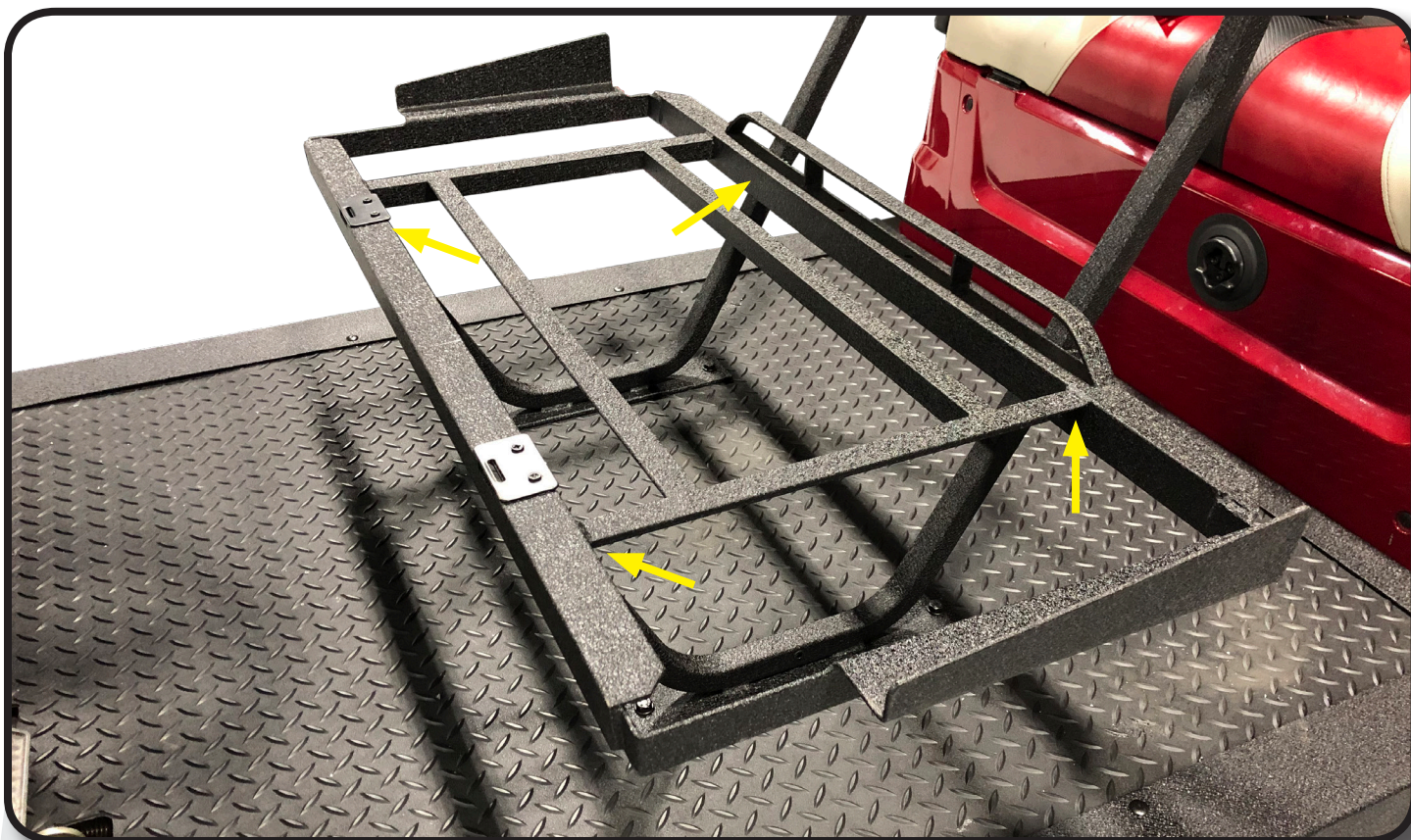

STEP 49

Attach rear Cup holder to seat frame using two 8x25mm bolts and hardware from Pack 4.



STEP 50

Attach Seat Frame Closeouts to supports using six fine thread screws from Pack 5.

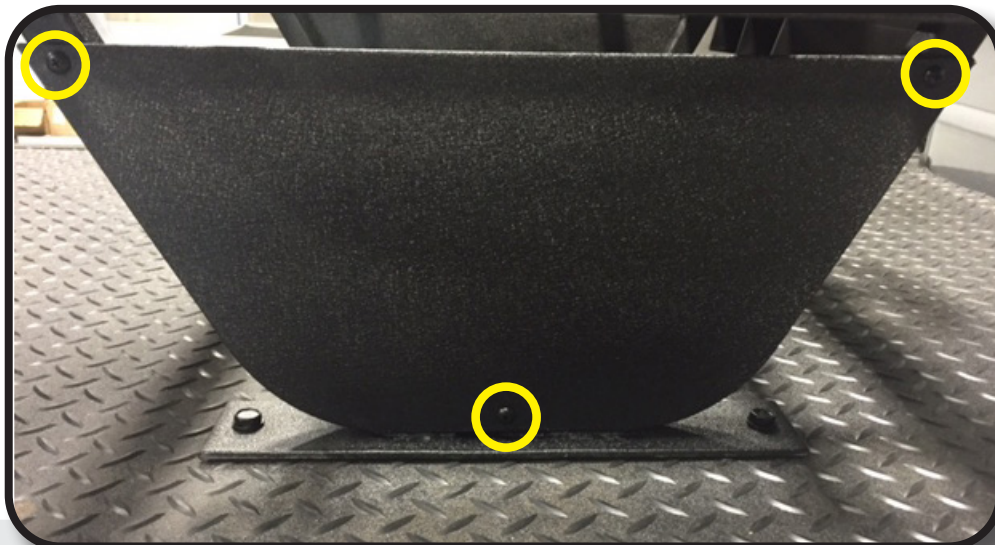

STEP 51

Attach Grab bar and front seat lean back cushion to supports using four 6x50mm bolts from Pack 5 as shown. You can now tighten all hardware on front seat pod and install front seat bottom.



STEP 52

After installation use P-Clamps and tie straps to secure any harnesses or additional wiring.

INSTALLATION COMPLETE

HARDWARE PACK (DACROMET COATED)

Pack 1

4 - 8mm x 75mm Hex Head Bolts
4 - 8mm x 45mm Hex Head Bolts
12 - 8mm x 17mm Flat Washers
4 - 8mm x 25mm Fender Washers
8 - 8mm Nylock Nuts

Pack 2

6 - 8mm x 55mm Hex Head Bolts
12 - 8mm x 17mm Flat Washers
6 - 8mm Nylock Nuts

Pack 3

26 - 5mm x 20mm Black Rivets

Pack 4

4 - 8mm x 45mm Hex Head Bolts
4 - 8mm x 35mm Hex Head Bolts
2 - 8mm x 25mm Hex Head Bolts
20 - 8mm x 17mm Flat Washers
10 - 8mm Nylock Nuts

Pack 5

6 - 4mm x 15mm Fine Thread Screws
4 - 6mm x 50mm Hex Head Bolts
4 - 6mm Flat Washers
4 - 6mm Lock Washers

Pack 6

10 - Plastic Rivets

Pack 7

3 - P Clamps

MADJAX

24-139 YAMAHA DRIVE STRETCH KIT
WARRANTY PARTS EXPLODED VIEW DIAGRAM
(See Page 2 for Warranty Part Number Chart)

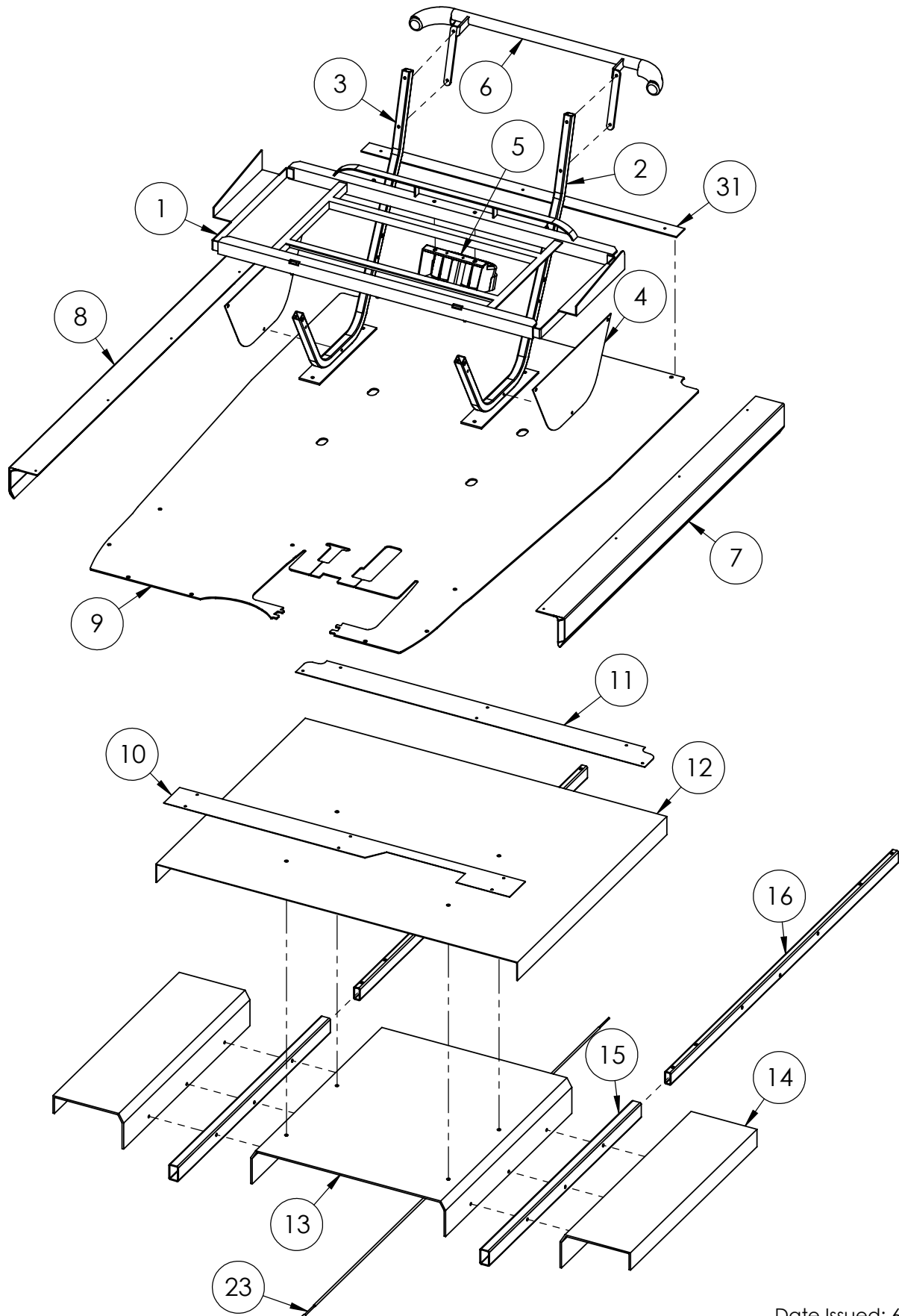

24-139 YAMAHA DRIVE2 STRETCH KIT**WARRANTY PARTS EXPLODED VIEW DIAGRAM**

See Page 1 for
Exploded View Diagram

ITEM #	DESCRIPTION	PART #	QTY
1	Seat Frame	W24-21-1	1
2	Seat Support Bracket (Driver Side)	W24-21-2	1
3	Seat Support Bracket (Pass Side)	W24-21-3	1
4	Seat Frame Closeout	W24-21-4	2
5	Cup Holder	W17-99-4	1
6	Grab Bar	W24-21-5	1
7	Floor Mat Retainer (Driver Side)	W24-21-6	1
8	Floor Mat Retainer (Pass Side)	W24-21-7	1
9	Diamond Plate Floor Mat	W24-21-33	1
10	Front Threshold	W24-21-8	1
11	Rear Threshold	W24-21-9	1
12	Floor Cover Plate	W24-21-31	1
13	Center Floor Support	W24-21-28	1
14	Side Floor Support	W24-21-32	2
15	Frame Extension Cover	W24-21-30	2
16	Frame Extension	W24-21-29	2
17	Key Switch Extension Harness	W24-139-8	1
18	Brake Switch Extension Harness	W24-21-16	1
19	Accelerator Switch Ext Harness	W24-139-3	1
20	Forward/Reverse Switch Ext Harness	W24-139-5	1
21	Reverse Buzzer Switch Ext Harness	W24-21-19	1
22	Brake Cable Driver Side	W24-024-31	1
23	Brake Cable Passenger Side	W24-024-32	1
24	Hardware Pack-1	W24-21-22	1
	M8x75 Hex Head Bolts		4
	M8 Fender Washers		4
	M8 Flat Washers		12
	M8 Nylock Nuts		8
	M8x45 Hex Head Bolts		4
25	Hardware Pack-2	W24-21-23	1
	M8x55 Hex Head Bolts		6
	M8 Flat Washers		12
	M8 Nylock Nuts		6
26	Hardware Pack-3	W24-21-24	1
	M5x20 Rivets		12
27	Hardware Pack-4	W24-21-25	1
	M8x45 Hex Head Bolts		4
	M8x35 Hex Head Bolts		4
	M8x25 Hex Head Bolts		2
	M8 Flat Washers		20
	M8 Nylock Nuts		10
28	Hardware Pack-5	W24-21-26	1
	M6x50 Hex Head Bolts		4
	M4x15 Fine Thread Screws		6
	M6 Lock Washers		4
	M6 Flat Washers		4
29	Hardware Pack-6	W24-21-27	1
	Self Tapping #2 Phillips Screws (1")		8
30	Zip Ties (Included in Box)		10
31	Rear Trim Floor Mat Retainer	W24-21-10	1
32	Light Kit Power Extension Harness	W24-21-20	1
33	Horn Harness	W24-139-9	1
34	Converter Harness	W24-139-4	1
35	Gauge Harness	W24-139-7	1
36	Throttle Sensor Harness	W24-139-6	1
37	Tail Light Extension Harness Driver Side	W24-139-1	1
38	Tail Light Extension Harness Pass Side	W24-139-2	1